

Verify this report at [gia.edu](http://gia.edu)

GIA COLORED DIAMOND REPORT

August 28, 2017  
 Report Type ..... Identification and Origin Report  
 GIA Report Number ..... 1172249796  
 Shape and Cutting Style . Cut-Cornered Square Modified  
 Brilliant  
 Measurements ..... 4.39 x 4.28 x 2.66 mm  
 Carat Weight ..... 0.44 carat  
 Color Grade ..... Fancy Brownish Pink  
 Color Origin ..... Natural  
 Color Distribution ..... Even  
 Inscription(s): GIA 1172249796

ADDITIONAL INFORMATION



The results documented in this report refer only to the diamond described, and were obtained using the techniques and equipment used by GIA at the time of examination. This report is not a guarantee or valuation. For additional information and important limitations and disclaimers, please see [www.gia.edu/terms](http://www.gia.edu/terms) or call +1 800 421 7250 or +1 760 603 4500. ©2014 Gemological Institute of America, Inc.

[reportcheck.gia.edu](http://reportcheck.gia.edu)



**GIA COLORED DIAMOND REPORT**

August 23, 2017  
 Report Type ..... Grading Report  
 GIA Report Number ..... 2185673370  
 Shape and Cutting Style . Cut-Cornered Square Modified Brilliant  
 Measurements ..... 3.94 x 3.80 x 2.49 mm  
 Carat Weight ..... 0.34 carat  
 Color Grade ..... Fancy Brown-Pink  
 Color Origin ..... Natural  
 Color Distribution ..... Even  
 Clarity Grade ..... I1  
 Proportions:

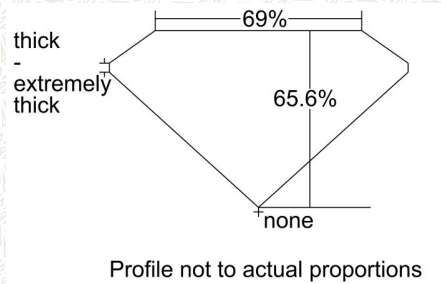

Polish ..... Good  
 Symmetry ..... Good  
 Fluorescence ..... Medium Blue

Inscription(s): GIA 2185673370

**Comments:** Clouds, pinpoints, internal graining and surface graining are not shown.

**ADDITIONAL INFORMATION**

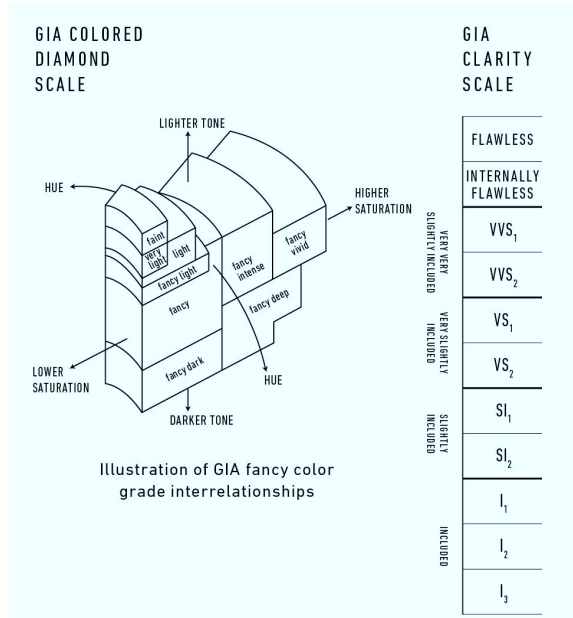

**CLARITY CHARACTERISTICS**

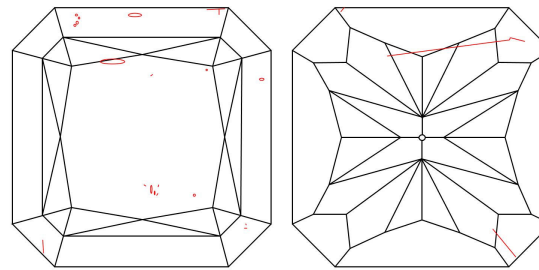

**KEY TO SYMBOLS\***

-  Feather
-  Crystal
-  Needle

\* Red symbols denote internal characteristics (inclusions). Green or black symbols denote external characteristics (blemishes). Diagram is an approximate representation of the diamond, and symbols shown indicate type, position, and approximate size of clarity characteristics. All clarity characteristics may not be shown. Details of finish are not shown.



[reportcheck.gia.edu](http://reportcheck.gia.edu)



The results documented in this report refer only to the diamond described, and were obtained using the techniques and equipment used by GIA at the time of examination. This report is not a guarantee or valuation. For additional information and important limitations and disclaimers, please see [www.gia.edu/terms](http://www.gia.edu/terms) or call +1 800 421 7250 or +1 760 603 4500. ©2014 Gemological Institute of America, Inc.

 THE SECURITY FEATURES IN THIS DOCUMENT, INCLUDING THE HOLOGRAM, SECURITY SCREEN AND MICROPRINT LINES, IN ADDITION TO THOSE NOT LISTED, EXCEED DOCUMENT SECURITY INDUSTRY GUIDELINES.

**GIA COLORED DIAMOND REPORT**

February 02, 2016  
 Report Type ..... Grading Report  
 GIA Report Number ..... 2175463287  
 Shape and Cutting Style ..... Oval Modified Brilliant  
 Measurements ..... 4.92 x 2.95 x 1.96 mm

Carat Weight ..... 0.23 carat  
 Color Grade ..... Fancy Brown-Pink  
 Color Origin ..... Natural  
 Color Distribution ..... Even  
 Clarity Grade ..... I1  
 Proportions:

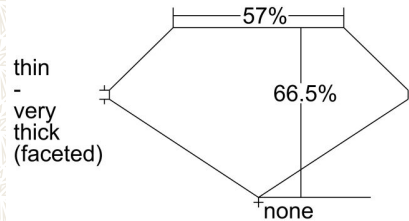

Profile not to actual proportions

Polish ..... Good  
 Symmetry ..... Good  
 Fluorescence ..... Faint  
 Inscription(s): GIA 2175463287

**ADDITIONAL INFORMATION**

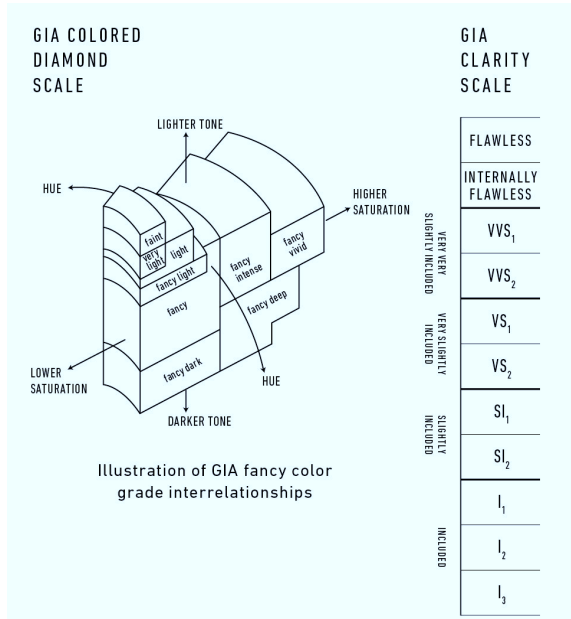

**CLARITY CHARACTERISTICS**

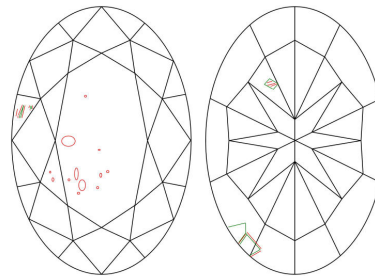

**KEY TO SYMBOLS\***

- Crystal
- △ Natural
- ◡ Cavity
- ~ Feather
- ⤴ Indented Natural

\* Red symbols denote internal characteristics (inclusions). Green or black symbols denote external characteristics (blemishes). Diagram is an approximate representation of the diamond, and symbols shown indicate type, position, and approximate size of clarity characteristics. All clarity characteristics may not be shown. Details of finish are not shown.



[reportcheck.gia.edu](http://reportcheck.gia.edu)



The results documented in this report refer only to the diamond described, and were obtained using the techniques and equipment used by GIA at the time of examination. This report is not a guarantee or valuation. For additional information and important limitations and disclaimers, please see [www.gia.edu/terms](http://www.gia.edu/terms) or call +1 800 421 7250 or +1 760 603 4500. ©2014 Gemological Institute of America, Inc.

 THE SECURITY FEATURES IN THIS DOCUMENT, INCLUDING THE HOLOGRAM, SECURITY SCREEN AND MICROPRINT LINES, IN ADDITION TO THOSE NOT LISTED, EXCEED DOCUMENT SECURITY INDUSTRY GUIDELINES.

Verify this report at [gia.edu](http://gia.edu)

**GIA COLORED DIAMOND REPORT**

May 5, 2017  
Report Type ..... Identification and Origin Report  
GIA Report Number ..... 1182311186  
Shape and Cutting Style . Round-Cornered Rectangular  
Modified Brilliant  
Measurements ..... 3.40 x 2.96 x 1.92 mm  
Carat Weight ..... 0.16 carat  
Color Grade ..... Fancy Purple-Pink  
Color Origin ..... Natural  
Color Distribution ..... Even  
Inscription(s): GIA 1182311186

**ADDITIONAL INFORMATION**

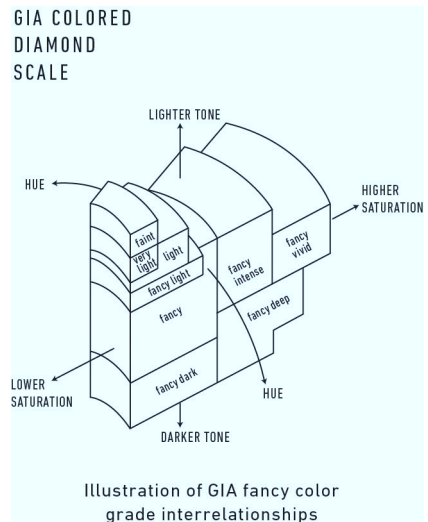

The results documented in this report refer only to the diamond described, and were obtained using the techniques and equipment used by GIA at the time of examination. This report is not a guarantee or valuation. For additional information and important limitations and disclaimers, please see [www.gia.edu/terms](http://www.gia.edu/terms) or call +1 800 421 7250 or +1 760 603 4500. ©2014 Gemological Institute of America, Inc.

[reportcheck.gia.edu](http://reportcheck.gia.edu)



 THE SECURITY FEATURES IN THIS DOCUMENT, INCLUDING THE HOLOGRAM, SECURITY SCREEN AND MICROPRINT LINES, IN ADDITION TO THOSE NOT LISTED, EXCEED DOCUMENT SECURITY INDUSTRY GUIDELINES.

Verify this report at [gia.edu](http://gia.edu)
**GIA COLORED DIAMOND REPORT**

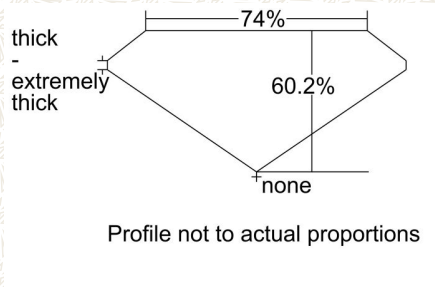
 August 01, 2017  
 Report Type ..... Grading Report  
 GIA Report Number ..... 1182584697  
 Shape and Cutting Style ..... Round-Cornered Square  
   Modified Brilliant  
 Measurements ..... 3.83 x 3.76 x 2.26 mm  
  
 Carat Weight ..... 0.27 carat  
 Color Grade ..... Fancy Light Brown-Pink  
 Color Origin ..... Natural  
 Color Distribution ..... Even  
 Clarity Grade ..... SI2  
 Proportions:

 Polish ..... Very Good  
 Symmetry ..... Good  
 Fluorescence ..... Medium Blue  
 Inscription(s): GIA 1182584697

Comments: Clouds, pinpoints and surface graining are not shown.

**ADDITIONAL INFORMATION**
**GIA COLORED DIAMOND SCALE**

Illustration of GIA fancy color grade interrelationships

**GIA CLARITY SCALE**

	FLAWLESS
	INTERNALLY FLAWLESS
VERY VERY SLIGHTLY INCLUDED	VVS <sub>1</sub>
	VVS <sub>2</sub>
VERY SLIGHTLY INCLUDED	VS <sub>1</sub>
	VS <sub>2</sub>
SLIGHTLY INCLUDED	SI <sub>1</sub>
	SI <sub>2</sub>
INCLUDED	I <sub>1</sub>
	I <sub>2</sub>
	I <sub>3</sub>

**CLARITY CHARACTERISTICS**

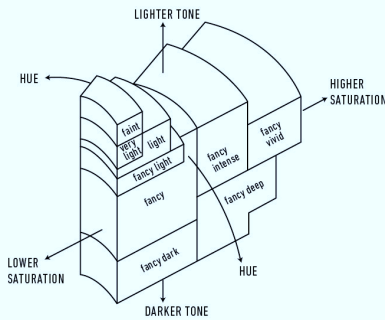
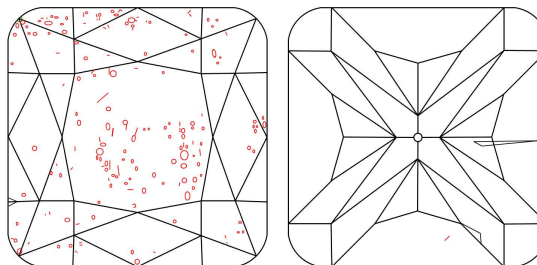
**KEY TO SYMBOLS\***

- Crystal
- ^ Extra Facet
- ~ Feather
- \ Needle
- ^ Natural

\* Red symbols denote internal characteristics (inclusions). Green or black symbols denote external characteristics (blemishes). Diagram is an approximate representation of the diamond, and symbols shown indicate type, position, and approximate size of clarity characteristics. All clarity characteristics may not be shown. Details of finish are not shown.



reportcheck.gia.edu

 The results documented in this report refer only to the diamond described, and were obtained using the techniques and equipment used by GIA at the time of examination. This report is not a guarantee or valuation. For additional information and important limitations and disclaimers, please see [www.gia.edu/terms](http://www.gia.edu/terms) or call +1 800 421 7250 or +1 760 603 4500. ©2014 Gemological Institute of America, Inc.

**GIA COLORED DIAMOND REPORT**

August 21, 2015  
 Report Type ..... Grading Report  
 GIA Report Number ..... 7208462556  
 Shape and Cutting Style ..... Oval Modified Brilliant  
 Measurements ..... 5.15 x 4.10 x 2.49 mm

Carat Weight ..... 0.40 carat  
 Color Grade ..... Fancy Orangy Pink  
 Color Origin ..... Natural  
 Color Distribution ..... Even  
 Clarity Grade ..... VS2  
 Proportions:

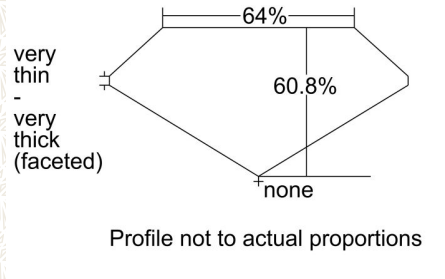

Polish ..... Good  
 Symmetry ..... Good  
 Fluorescence ..... Faint  
 Inscription(s): GIA 7208462556

**Comments:** Additional clouds are not shown. Internal graining is not shown.

**ADDITIONAL INFORMATION**

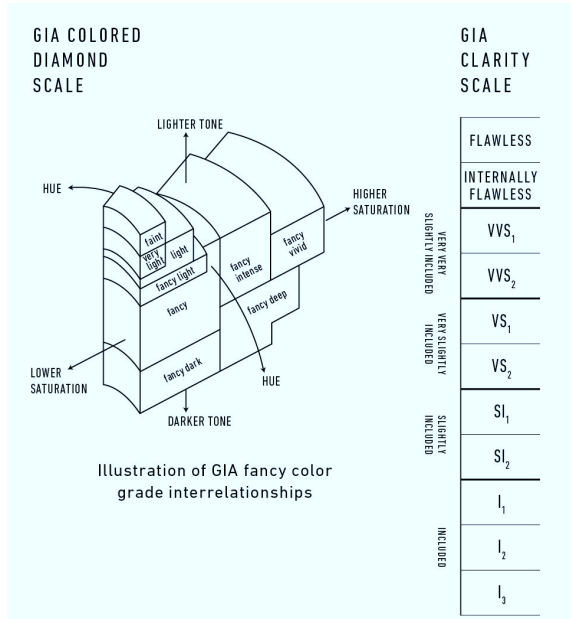

**CLARITY CHARACTERISTICS**

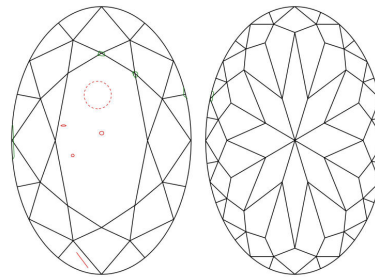

**KEY TO SYMBOLS\***

- Crystal
- ⊙ Cloud
- ~ Feather
- △ Natural

\* Red symbols denote internal characteristics (inclusions). Green or black symbols denote external characteristics (blemishes). Diagram is an approximate representation of the diamond, and symbols shown indicate type, position, and approximate size of clarity characteristics. All clarity characteristics may not be shown. Details of finish are not shown.



[reportcheck.gia.edu](http://reportcheck.gia.edu)



The results documented in this report refer only to the diamond described, and were obtained using the techniques and equipment used by GIA at the time of examination. This report is not a guarantee or valuation. For additional information and important limitations and disclaimers, please see [www.gia.edu/terms](http://www.gia.edu/terms) or call +1 800 421 7250 or +1 760 603 4500. ©2014 Gemological Institute of America, Inc.

 THE SECURITY FEATURES IN THIS DOCUMENT, INCLUDING THE HOLOGRAM, SECURITY SCREEN AND MICROPRINT LINES, IN ADDITION TO THOSE NOT LISTED, EXCEED DOCUMENT SECURITY INDUSTRY GUIDELINES.

**GIA COLORED DIAMOND REPORT**

August 14, 2015  
 Report Type ..... Grading Report  
 GIA Report Number ..... 6205461493  
 Shape and Cutting Style ..... Pear Modified Brilliant  
 Measurements ..... 4.63 x 3.89 x 2.22 mm

Carat Weight ..... 0.29 carat  
 Color Grade ..... Fancy Orangy Pink  
 Color Origin ..... Natural  
 Color Distribution ..... Even  
 Clarity Grade ..... SI1  
 Proportions:

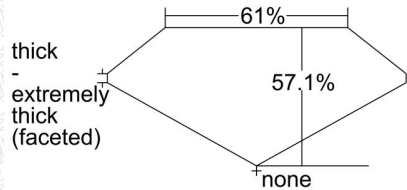

Profile not to actual proportions

Polish ..... Good  
 Symmetry ..... Good  
 Fluorescence ..... Faint  
 Inscription(s): GIA 6205461493

Comments: Surface graining is not shown.

**ADDITIONAL INFORMATION**

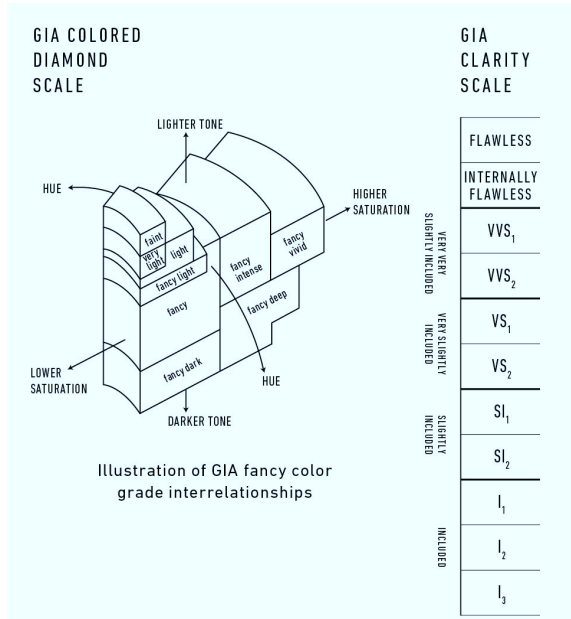

**CLARITY CHARACTERISTICS**

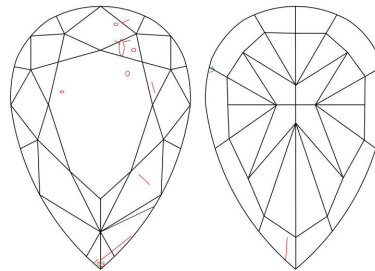

**KEY TO SYMBOLS\***

- Crystal
- △ Extra Facet
- ~ Feather
- ◐ Cavity
- ∧ Natural

\* Red symbols denote internal characteristics (inclusions). Green or black symbols denote external characteristics (blemishes). Diagram is an approximate representation of the diamond, and symbols shown indicate type, position, and approximate size of clarity characteristics. All clarity characteristics may not be shown. Details of finish are not shown.



[reportcheck.gia.edu](http://reportcheck.gia.edu)



The results documented in this report refer only to the diamond described, and were obtained using the techniques and equipment used by GIA at the time of examination. This report is not a guarantee or valuation. For additional information and important limitations and disclaimers, please see [www.gia.edu/terms](http://www.gia.edu/terms) or call +1 800 421 7250 or +1 760 603 4500. ©2014 Gemological Institute of America, Inc.

THE SECURITY FEATURES IN THIS DOCUMENT, INCLUDING THE HOLOGRAM, SECURITY SCREEN AND MICROPRINT LINES, IN ADDITION TO THOSE NOT LISTED, EXCEED DOCUMENT SECURITY INDUSTRY GUIDELINES.

**GIA COLORED DIAMOND REPORT**

August 14, 2015  
 Report Type ..... Grading Report  
 GIA Report Number ..... 1207459767  
 Shape and Cutting Style ..... Marquise Modified Brilliant  
 Measurements ..... 5.52 x 3.00 x 2.31 mm

Carat Weight ..... 0.26 carat  
 Color Grade ..... Fancy Orangy Pink  
 Color Origin ..... Natural  
 Color Distribution ..... Even  
 Clarity Grade ..... SI2  
 Proportions:

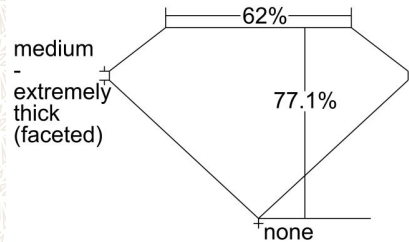

Profile not to actual proportions

Polish ..... Good  
 Symmetry ..... Good  
 Fluorescence ..... Faint  
 Inscription(s): GIA 1207459767

Comments: Clouds are not shown. Pinpoints are not shown.

**ADDITIONAL INFORMATION**

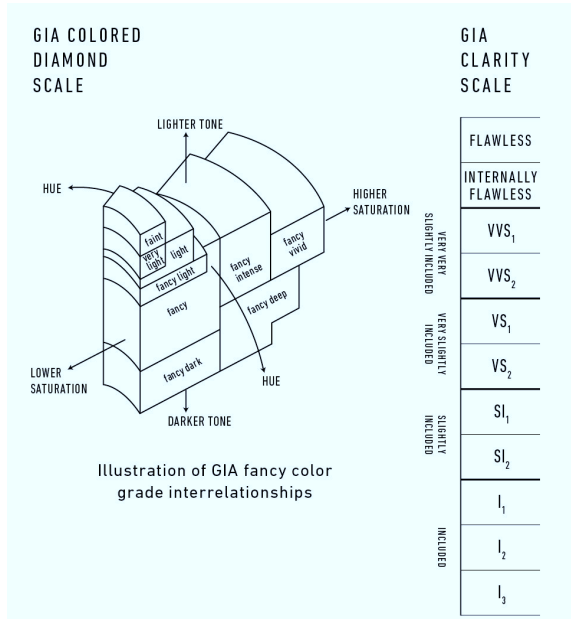

**CLARITY CHARACTERISTICS**

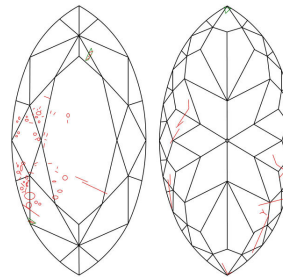

**KEY TO SYMBOLS\***

- Feather
- Crystal
- Cavity
- Needle
- Natural

\* Red symbols denote internal characteristics (inclusions). Green or black symbols denote external characteristics (blemishes). Diagram is an approximate representation of the diamond, and symbols shown indicate type, position, and approximate size of clarity characteristics. All clarity characteristics may not be shown. Details of finish are not shown.



The results documented in this report refer only to the diamond described, and were obtained using the techniques and equipment used by GIA at the time of examination. This report is not a guarantee or valuation. For additional information and important limitations and disclaimers, please see [www.gia.edu/terms](http://www.gia.edu/terms) or call +1 800 421 7250 or +1 760 603 4500. ©2014 Gemological Institute of America, Inc.

[reportcheck.gia.edu](http://reportcheck.gia.edu)



 THE SECURITY FEATURES IN THIS DOCUMENT, INCLUDING THE HOLOGRAM, SECURITY SCREEN AND MICROPRINT LINES, IN ADDITION TO THOSE NOT LISTED, EXCEED DOCUMENT SECURITY INDUSTRY GUIDELINES.