

**GIA COLORED DIAMOND REPORT**

June 21, 2016  
 Report Type .....Grading Report  
 GIA Report Number ..... 1176691493  
 Shape and Cutting Style ..... Round-Cornered Square  
 Modified Brilliant  
 Measurements ..... 3.66 x 3.58 x 2.49 mm  
  
 Carat Weight ..... 0.29 carat  
 Color Grade ..... Fancy Deep Orangi Yellow  
 Color Origin ..... Natural  
 Color Distribution ..... Even  
 Clarity Grade ..... SI1  
 Proportions:

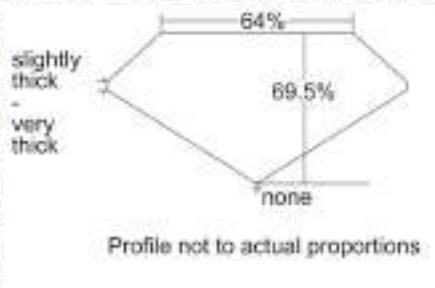

Polish ..... Good  
 Symmetry ..... Good  
 Fluorescence ..... None

Inscription(s): GIA 1176691493

Comments: Pinpoints are not shown.

**ADDITIONAL INFORMATION**

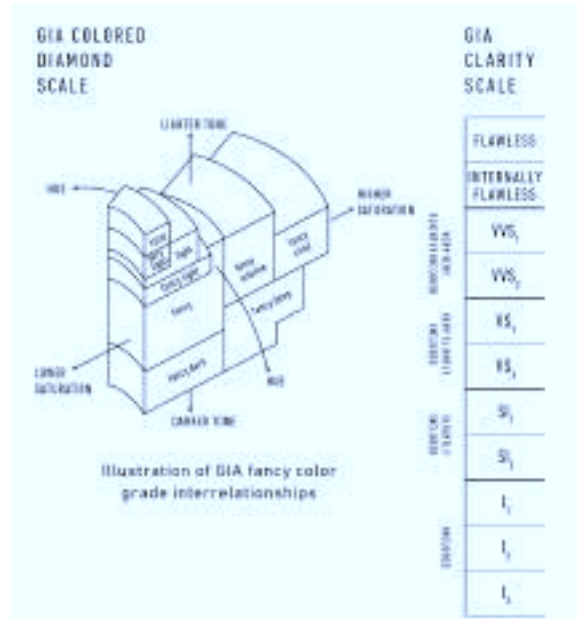

**CLARITY CHARACTERISTICS**

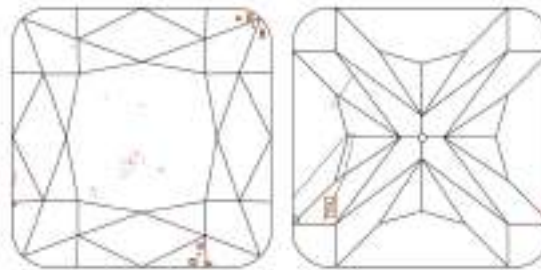

**KEY TO SYMBOLS\***

-  Feather
-  Needle
-  Etch Channel
-  Extra Facet
-  Crystal
-  Cloud

\* Red symbols denote internal characteristics (inclusions). Green or black symbols denote external characteristics (blemishes). Diagram is an approximate representation of the diamond, and symbols shown indicate type, position, and approximate size of clarity characteristics. All clarity characteristics may not be shown. Details of finish are not shown.



[reportcheck.gia.edu](http://reportcheck.gia.edu)



The results documented in this report refer only to the diamond described, and were obtained using the techniques and equipment used by GIA at the time of examination. This report is not a guarantee or valuation. For additional information and important limitations and disclaimers, please see [www.gia.edu/terms](http://www.gia.edu/terms) or call +1 800 421 7250 or +1 760 603 4500. ©2014 Gemological Institute of America, Inc.

 THE SECURITY FEATURES IN THIS DOCUMENT, INCLUDING THE HOLOGRAM, SECURITY SCREEN AND MICROPRINT LINES, IN ADDITION TO THOSE NOT LISTED, EXCEED DOCUMENT SECURITY INDUSTRY GUIDELINES.

**GIA COLORED DIAMOND REPORT**

June 24, 2016  
 Report Type ..... Grading Report  
 GIA Report Number ..... 1172691497  
 Shape and Cutting Style ..... Cushion Modified Brilliant  
 Measurements ..... 4.01 x 3.59 x 2.76 mm

Carat Weight ..... 0.36 carat  
 Color Grade ..... Fancy Deep Orangy Yellow  
 Color Origin ..... Natural  
 Color Distribution ..... Even  
 Clarity Grade ..... VVS2  
 Proportions:

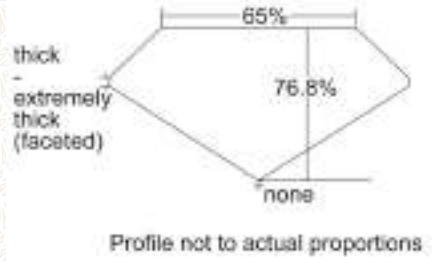

Polish ..... Very Good  
 Symmetry ..... Good  
 Fluorescence ..... None  
 Inscription(s): GIA 1172691497

**Comments:** Clouds are not shown. Pinpoints are not shown.

**ADDITIONAL INFORMATION**

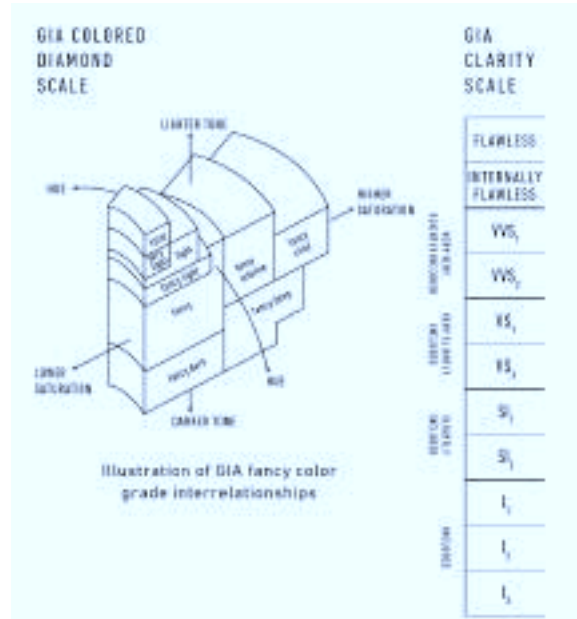

**CLARITY CHARACTERISTICS**

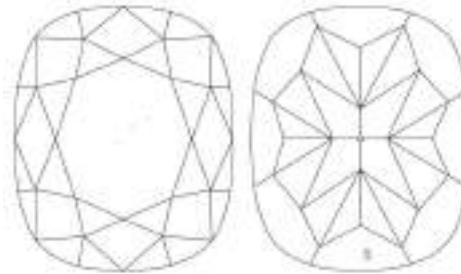

**KEY TO SYMBOLS\***

- Needle
- Indented Natural

\* Red symbols denote internal characteristics (inclusions). Green or black symbols denote external characteristics (blemishes). Diagram is an approximate representation of the diamond, and symbols shown indicate type, position, and approximate size of clarity characteristics. All clarity characteristics may not be shown. Details of finish are not shown.



[reportcheck.gia.edu](http://reportcheck.gia.edu)



The results documented in this report refer only to the diamond described, and were obtained using the techniques and equipment used by GIA at the time of examination. This report is not a guarantee or valuation. For additional information and important limitations and disclaimers, please see [www.gia.edu/terms](http://www.gia.edu/terms) or call +1 800 421 7250 or +1 760 603 4500. ©2014 Gemological Institute of America, Inc.

THE SECURITY FEATURES IN THIS DOCUMENT, INCLUDING THE HOLOGRAM, SECURITY SCREEN AND MICROPRINT LINES, IN ADDITION TO THOSE NOT LISTED, EXCEED DOCUMENT SECURITY INDUSTRY GUIDELINES.

**GIA COLORED DIAMOND REPORT**

June 23, 2016

Report Type ..... Grading Report

GIA Report Number ..... 1176691624

Shape and Cutting Style ..... Cushion Modified Brilliant

Measurements ..... 3.95 x 3.73 x 2.32 mm

Carat Weight ..... 0.31 carat

Color Grade ..... Fancy Intense Orangy Yellow

Color Origin ..... Natural

Color Distribution ..... Even

Clarity Grade ..... VS1

Proportions:

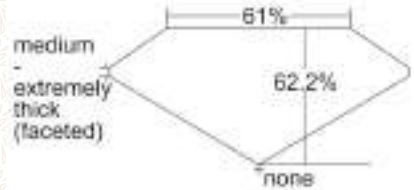

Profile not to actual proportions

Polish ..... Very Good



Symmetry ..... Good

Fluorescence ..... None

Inscription(s): GIA 1176691624

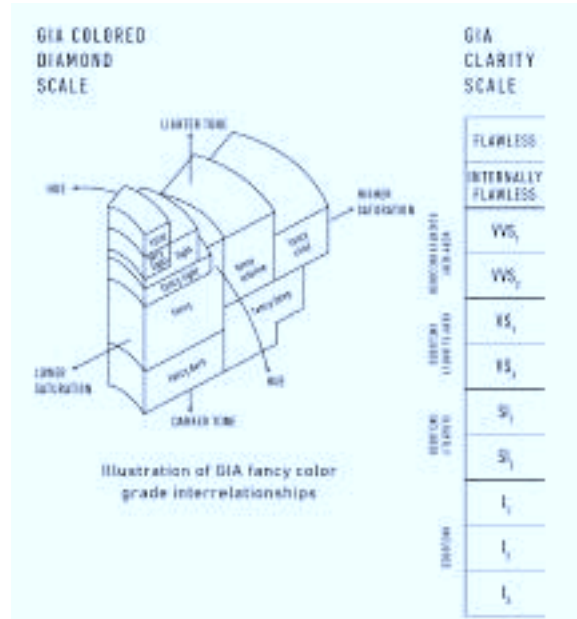
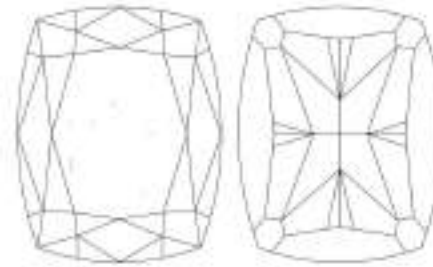
**Comments:** Clouds are not shown. Additional pinpoints are not shown.

**ADDITIONAL INFORMATION**

**CLARITY CHARACTERISTICS**

**KEY TO SYMBOLS\***

-  Feather
-  Needle
-  Pinpoint

\* Red symbols denote internal characteristics (inclusions). Green or black symbols denote external characteristics (blemishes). Diagram is an approximate representation of the diamond, and symbols shown indicate type, position, and approximate size of clarity characteristics. All clarity characteristics may not be shown. Details of finish are not shown.

[reportcheck.gia.edu](http://reportcheck.gia.edu)

 The results documented in this report refer only to the diamond described, and were obtained using the techniques and equipment used by GIA at the time of examination. This report is not a guarantee or valuation. For additional information and important limitations and disclaimers, please see [www.gia.edu/terms](http://www.gia.edu/terms) or call +1 800 421 7250 or +1 760 603 4500. ©2014 Gemological Institute of America, Inc.

 THE SECURITY FEATURES IN THIS DOCUMENT, INCLUDING THE HOLOGRAM, SECURITY SCREEN AND MICROPRINT LINES, IN ADDITION TO THOSE NOT LISTED, EXCEED DOCUMENT SECURITY INDUSTRY GUIDELINES.

**GIA COLORED DIAMOND REPORT**

June 22, 2016  
 Report Type ..... Grading Report  
 GIA Report Number ..... 1176691492  
 Shape and Cutting Style ..... Cushion Modified Brilliant  
 Measurements ..... 4.37 x 3.44 x 2.38 mm

Carat Weight ..... 0.30 carat  
 Color Grade ..... Fancy Intense Orangy Yellow  
 Color Origin ..... Natural  
 Color Distribution ..... Even  
 Clarity Grade ..... SI1  
 Proportions:

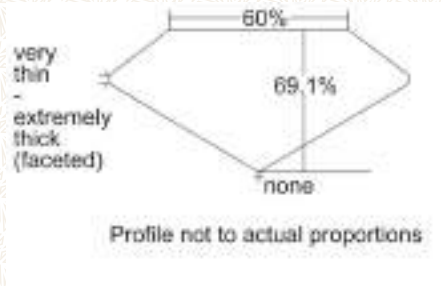

Polish ..... Good  
 Symmetry ..... Good  
 Fluorescence ..... None  
 Inscription(s): GIA 1176691492

**Comments:** Additional clouds are not shown. Pinpoints are not shown.

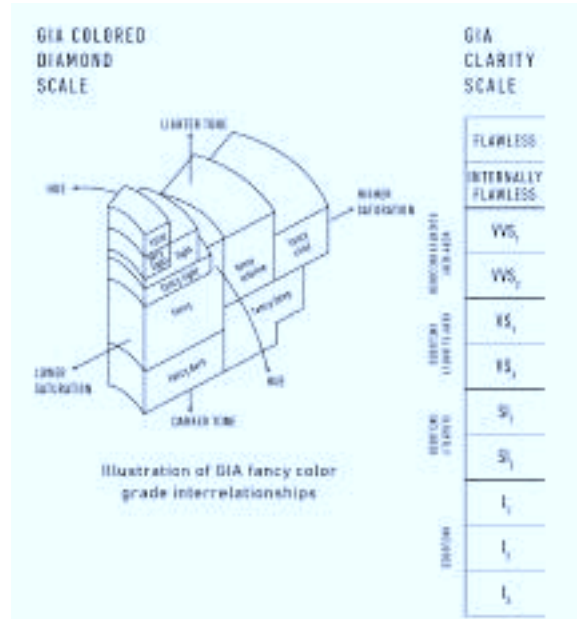
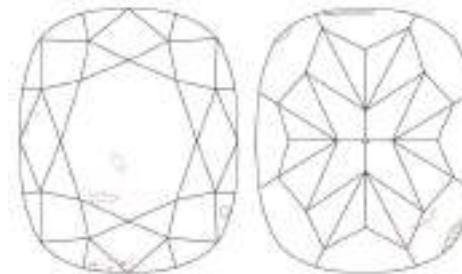
**ADDITIONAL INFORMATION**

**CLARITY CHARACTERISTICS**

**KEY TO SYMBOLS\***

- Crystal
- Feather
- Cloud
- Cavity
- ▲ Indented Natural
- ▲ Natural

\* Red symbols denote internal characteristics (inclusions). Green or black symbols denote external characteristics (blemishes). Diagram is an approximate representation of the diamond, and symbols shown indicate type, position, and approximate size of clarity characteristics. All clarity characteristics may not be shown. Details of finish are not shown.



[reportcheck.gia.edu](http://reportcheck.gia.edu)

The results documented in this report refer only to the diamond described, and were obtained using the techniques and equipment used by GIA at the time of examination. This report is not a guarantee or valuation. For additional information and important limitations and disclaimers, please see [www.gia.edu/terms](http://www.gia.edu/terms) or call +1 800 421 7250 or +1 760 603 4500. ©2014 Gemological Institute of America, Inc.

Verify this report at [gia.edu](http://gia.edu)

**GIA COLORED DIAMOND REPORT**

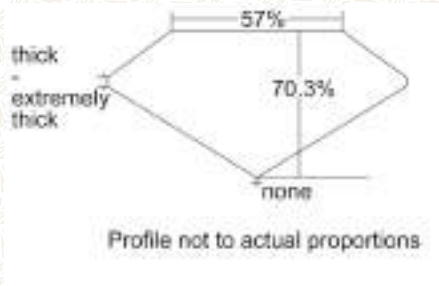
June 24, 2016  
 Report Type .....Grading Report  
 GIA Report Number ..... 1172691503  
 Shape and Cutting Style . Round-Cornered Rectangular  
 Modified Brilliant  
 Measurements ..... 3.91 x 3.52 x 2.48 mm  
  
 Carat Weight ..... 0.31 carat  
 Color Grade ..... Fancy Intense Orange-Yellow  
 Color Origin ..... Natural  
 Color Distribution ..... Even  
 Clarity Grade ..... SI2  
 Proportions:



Polish ..... Very Good  
 Symmetry ..... Fair  
 Fluorescence ..... Faint  
 Inscription(s): GIA 1172691503

**Comments:** Clouds are not shown. Pinpoints are not shown.

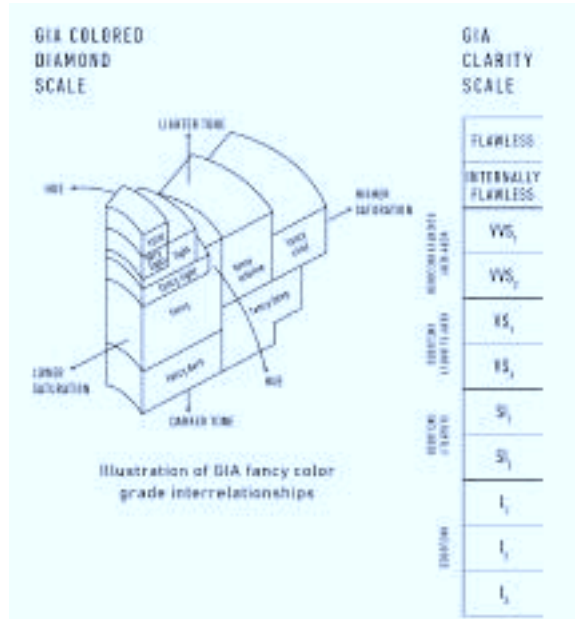
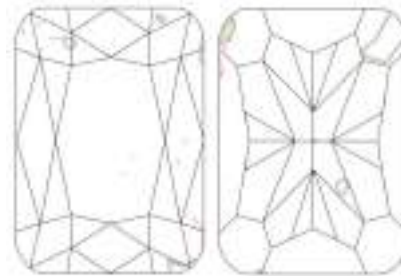
**ADDITIONAL INFORMATION**

**CLARITY CHARACTERISTICS**

**KEY TO SYMBOLS\***

-  Feather
-  Needle
-  Cavity
-  Indented Natural
-  Crystal

\* Red symbols denote internal characteristics (inclusions). Green or black symbols denote external characteristics (blemishes). Diagram is an approximate representation of the diamond, and symbols shown indicate type, position, and approximate size of clarity characteristics. All clarity characteristics may not be shown. Details of finish are not shown.



The results documented in this report refer only to the diamond described, and were obtained using the techniques and equipment used by GIA at the time of examination. This report is not a guarantee or valuation. For additional information and important limitations and disclaimers, please see [www.gia.edu/terms](http://www.gia.edu/terms) or call +1 800 421 7250 or +1 760 603 4500.  
 ©2014 Gemological Institute of America, Inc.

[reportcheck.gia.edu](http://reportcheck.gia.edu)



 THE SECURITY FEATURES IN THIS DOCUMENT, INCLUDING THE HOLOGRAM, SECURITY SCREEN AND MICROPRINT LINES, IN ADDITION TO THOSE NOT LISTED, EXCEED DOCUMENT SECURITY INDUSTRY GUIDELINES.

## FACSIMILE

This is a digital representation of the original GIA Report. This representation might not be accepted in lieu of the original GIA Report in certain circumstances. The original GIA Report includes certain security features which are not reproducible on this facsimile.

## GIA COLORED DIAMOND REPORT

June 25, 2016  
Report Type .....Grading Report  
GIA Report Number ..... 1176691516  
Shape and Cutting Style . Round-Cornered Rectangular  
Modified Brilliant  
Measurements ..... 4.04 x 3.67 x 2.17 mm

Carat Weight ..... 0.28 carat  
Color Grade ..... Fancy Intense Orange-Yellow  
Color Origin ..... Natural  
Color Distribution ..... Even  
Clarity Grade ..... VS2  
Proportions:

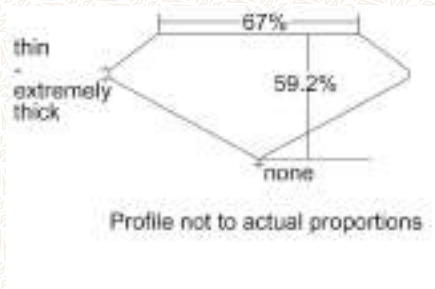

Polish ..... Good  
Symmetry ..... Good  
Fluorescence ..... None

Inscription(s): GIA 1176691516

**Comments:** Additional clouds are not shown. Pinpoints are not shown.

## ADDITIONAL INFORMATION

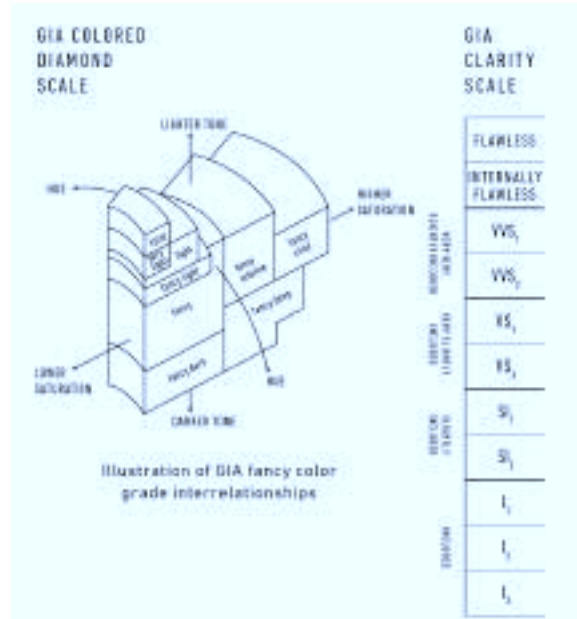

## CLARITY CHARACTERISTICS

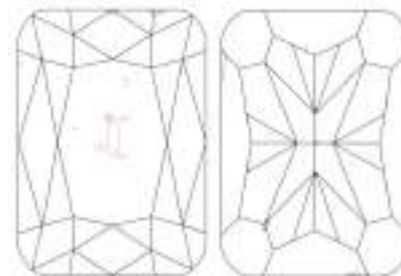

## KEY TO SYMBOLS\*

- Crystal
- Cloud
- Feather
- Needle
- Indented Natural
- Natural
- Extra Facet

\* Red symbols denote internal characteristics (inclusions). Green or black symbols denote external characteristics (blemishes). Diagram is an approximate representation of the diamond, and symbols shown indicate type, position, and approximate size of clarity characteristics. All clarity characteristics may not be shown. Details of finish are not shown.



The results documented in this report refer only to the diamond described, and were obtained using the techniques and equipment used by GIA at the time of examination. This report is not a guarantee or valuation. For additional information and important limitations and disclaimers, please see [www.gia.edu/terms](http://www.gia.edu/terms) or call +1 800 421 7250 or +1 760 603 4500.  
©2014 Gemological Institute of America, Inc.

[reportcheck.gia.edu](http://reportcheck.gia.edu)





GIA REPORT  
5171691507

Verify this report at [gia.edu](http://gia.edu)

FACSIMILE

This is a digital representation of the original GIA Report. This representation might not be accepted in lieu of the original GIA Report in certain circumstances. The original GIA Report includes certain security features which are not reproducible on this facsimile.

GIA COLORED DIAMOND REPORT

June 20, 2016  
Report Type ..... Identification and Origin Report  
GIA Report Number ..... 5171691507  
Shape and Cutting Style ..... Round-Cornered Square  
Modified Brilliant  
Measurements ..... 3.49 x 3.47 x 2.49 mm  
Carat Weight ..... 0.28 carat  
Color Grade ..... Fancy Intense Orange-Yellow  
Color Origin ..... Natural  
Color Distribution ..... Even  
Inscription(s): GIA 5171691507

ADDITIONAL INFORMATION

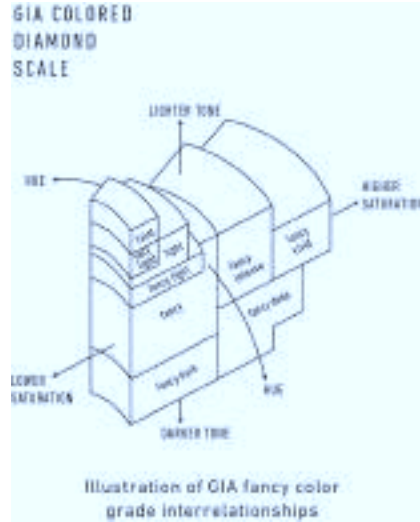

The results documented in this report refer only to the diamond described, and were obtained using the techniques and equipment used by GIA at the time of examination. This report is not a guarantee or valuation. For additional information and important limitations and disclaimers, please see [www.gia.edu/terms](http://www.gia.edu/terms) or call +1 800 421 7250 or +1 760 603 4500. ©2014 Gemological Institute of America, Inc.

[reportcheck.gia.edu](http://reportcheck.gia.edu)



 THE SECURITY FEATURES IN THIS DOCUMENT, INCLUDING THE HOLOGRAM, SECURITY SCREEN AND MICROPRINT LINES, IN ADDITION TO THOSE NOT LISTED, EXCEED DOCUMENT SECURITY INDUSTRY GUIDELINES.

**GIA COLORED DIAMOND REPORT**

June 24, 2016

Report Type .....Grading Report

GIA Report Number ..... 2175691498

Shape and Cutting Style ..... Cushion Brilliant

Measurements ..... 4.00 x 3.43 x 2.30 mm

Carat Weight ..... 0.24 carat

Color Grade ..... Fancy Deep Orangy Yellow

Color Origin ..... Natural

Color Distribution ..... Even

Clarity Grade ..... VS2

Proportions:

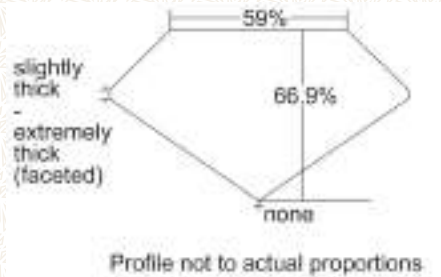

Polish ..... Good

Symmetry ..... Good

Fluorescence ..... None

Inscription(s): GIA 2175691498

**Comments:** Additional clouds are not shown. Pinpoints are not shown.

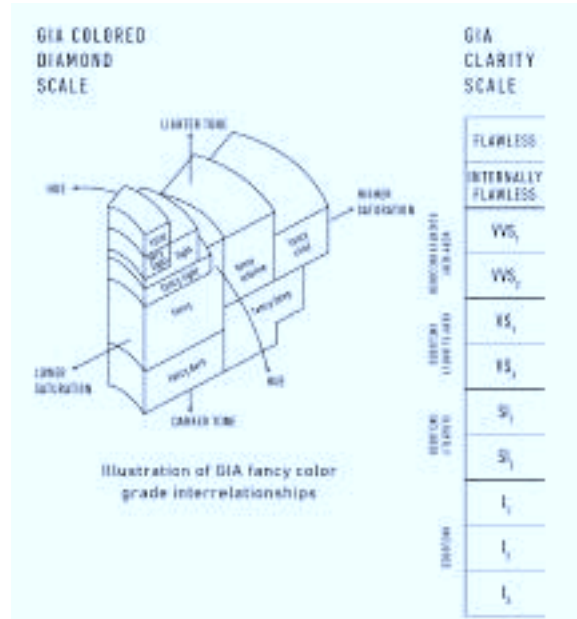
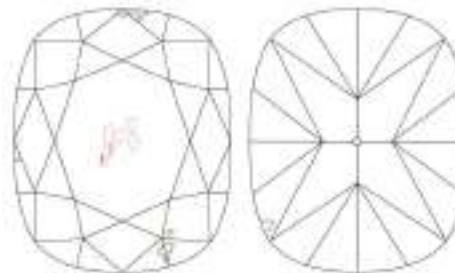
**ADDITIONAL INFORMATION**

**CLARITY CHARACTERISTICS**

**KEY TO SYMBOLS\***

- Crystal
- Cloud
- Feather
- Indented Natural
- Needle
- Etch Channel

\* Red symbols denote internal characteristics (inclusions). Green or black symbols denote external characteristics (blemishes). Diagram is an approximate representation of the diamond, and symbols shown indicate type, position, and approximate size of clarity characteristics. All clarity characteristics may not be shown. Details of finish are not shown.

 The results documented in this report refer only to the diamond described, and were obtained using the techniques and equipment used by GIA at the time of examination. This report is not a guarantee or valuation. For additional information and important limitations and disclaimers, please see [www.gia.edu/terms](http://www.gia.edu/terms) or call +1 800 421 7250 or +1 760 603 4500. ©2014 Gemological Institute of America, Inc.

[reportcheck.gia.edu](http://reportcheck.gia.edu)

 THE SECURITY FEATURES IN THIS DOCUMENT, INCLUDING THE HOLOGRAM, SECURITY SCREEN AND MICROPRINT LINES, IN ADDITION TO THOSE NOT LISTED, EXCEED DOCUMENT SECURITY INDUSTRY GUIDELINES.





GIA REPORT  
1172729307

FACSIMILE

This is a digital representation of the original GIA Report. This representation might not be accepted in lieu of the original GIA Report in certain circumstances. The original GIA Report includes certain security features which are not reproducible on this facsimile.

Verify this report at [gia.edu](http://gia.edu)

GIA COLORED DIAMOND REPORT

July 28, 2016  
Report Type .....Identification and Origin Report  
GIA Report Number ..... 1172729307  
Shape and Cutting Style ..... Round-Cornered Square  
Modified Brilliant  
Measurements ..... 3.78 x 3.64 x 2.42 mm  
Carat Weight ..... 0.31 carat  
Color Grade ..... Fancy Deep Orangy Yellow  
Color Origin ..... Natural  
Color Distribution ..... Even  
Inscription(s): GIA 1172729307

ADDITIONAL INFORMATION

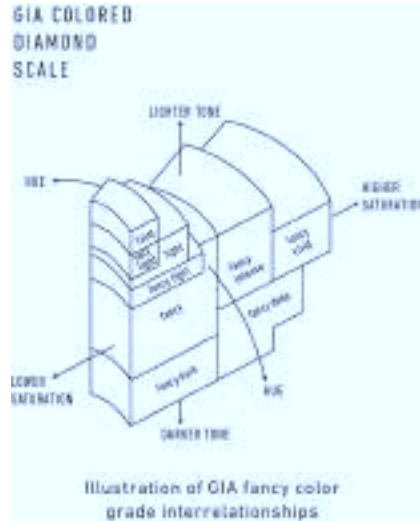

The results documented in this report refer only to the diamond described, and were obtained using the techniques and equipment used by GIA at the time of examination. This report is not a guarantee or valuation. For additional information and important limitations and disclaimers, please see [www.gia.edu/terms](http://www.gia.edu/terms) or call +1 800 421 7250 or +1 760 603 4500. ©2014 Gemological Institute of America, Inc.

[reportcheck.gia.edu](http://reportcheck.gia.edu)



GIA COLORED DIAMOND REPORT

July 21, 2016  
Report Type ..... Grading Report  
GIA Report Number ..... 1176729561  
Shape and Cutting Style ..... Round-Cornered Square Modified Brilliant  
Measurements ..... 3.92 x 3.89 x 2.68 mm  
Carat Weight ..... 0.41 carat  
Color Grade ..... Fancy Deep Orangy Yellow  
Color Origin ..... Natural  
Color Distribution ..... Even  
Clarity Grade ..... SI1  
Proportions:

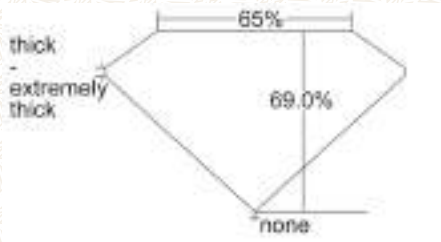

Profile not to actual proportions

Polish ..... Very Good  
Symmetry ..... Good  
Fluorescence ..... None  
Inscription(s): GIA 1176729561

Comments: Additional clouds are not shown.

ADDITIONAL INFORMATION

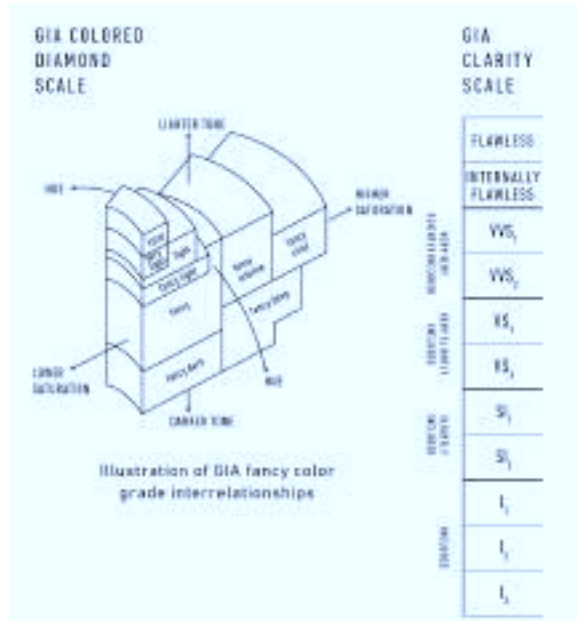

CLARITY CHARACTERISTICS

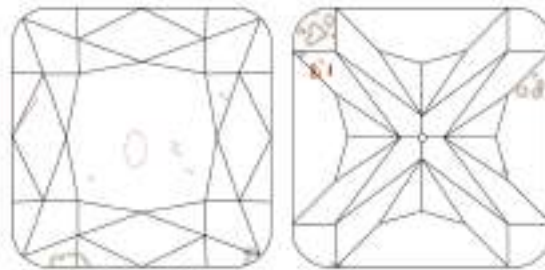

KEY TO SYMBOLS\*

- Feather
- Indented Natural
- Etch Channel
- Cloud

\* Red symbols denote internal characteristics (inclusions). Green or black symbols denote external characteristics (blemishes). Diagram is an approximate representation of the diamond, and symbols shown indicate type, position, and approximate size of clarity characteristics. All clarity characteristics may not be shown. Details of finish are not shown.



The results documented in this report refer only to the diamond described, and were obtained using the techniques and equipment used by GIA at the time of examination. This report is not a guarantee or valuation. For additional information and important limitations and disclaimers, please see [www.gia.edu/terms](http://www.gia.edu/terms) or call +1 800 421 7250 or +1 760 603 4500. ©2014 Gemological Institute of America, Inc.

[reportcheck.gia.edu](http://reportcheck.gia.edu)



Verify this report at [gia.edu](http://gia.edu)

**GIA COLORED DIAMOND REPORT**

July 19, 2016  
 Report Type ..... Grading Report  
 GIA Report Number ..... 2175729016  
 Shape and Cutting Style . Round-Cornered Rectangular  
    Modified Brilliant  
 Measurements ..... 4.38 x 3.63 x 2.58 mm  
  
 Carat Weight ..... 0.40 carat  
 Color Grade ..... Fancy Intense Orange-Yellow  
 Color Origin ..... Natural  
 Color Distribution ..... Even  
 Clarity Grade ..... SI2  
 Proportions:

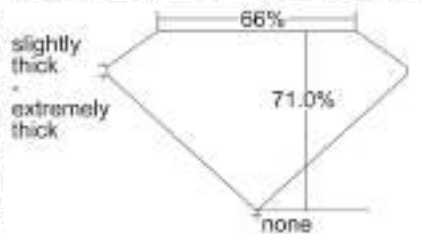

Profile not to actual proportions

Polish ..... Very Good  
 Symmetry ..... Good  
 Fluorescence ..... None  
 Inscription(s): GIA 2175729016

Comments: Additional clouds are not shown.

**ADDITIONAL INFORMATION**

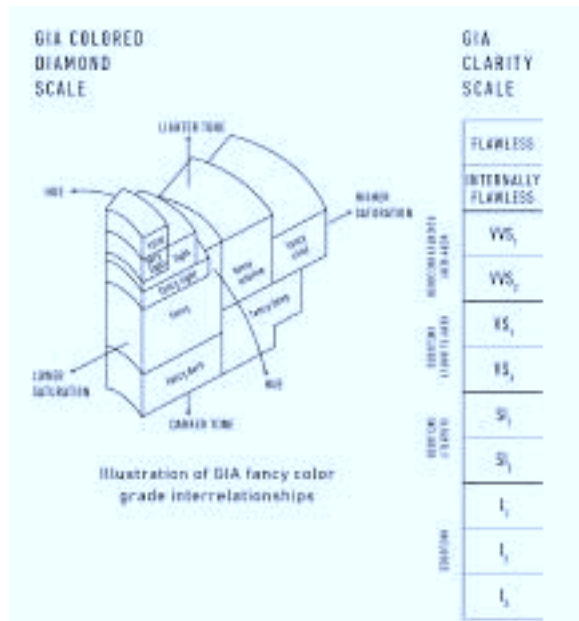

CLARITY CHARACTERISTICS

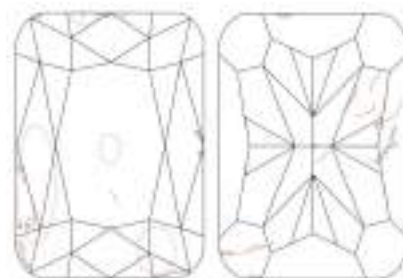

KEY TO SYMBOLS\*

- ☐ Cloud
- ✦ Crystal
- ☞ Feather
- ☑ Cavity
- ↪ Indented Natural

\* Red symbols denote internal characteristics (inclusions). Green or black symbols denote external characteristics (blemishes). Diagram is an approximate representation of the diamond, and symbols shown indicate type, position, and approximate size of clarity characteristics. All clarity characteristics may not be shown. Details of finish are not shown.



[reportcheck.gia.edu](http://reportcheck.gia.edu)



The results documented in this report refer only to the diamond described, and were obtained using the techniques and equipment used by GIA at the time of examination. This report is not a guarantee or valuation. For additional information and important limitations and disclaimers, please see [www.gia.edu/terms](http://www.gia.edu/terms) or call +1 800 421 7250 or +1 760 603 4500. ©2014 Gemological Institute of America, Inc.

 THE SECURITY FEATURES IN THIS DOCUMENT, INCLUDING THE HOLOGRAM, SECURITY SCREEN AND MICROPRINT LINES, IN ADDITION TO THOSE NOT LISTED, EXCEED DOCUMENT SECURITY INDUSTRY GUIDELINES.

**GIA COLORED DIAMOND REPORT**

July 20, 2016  
 Report Type ..... Grading Report  
 GIA Report Number ..... 2171729289  
 Shape and Cutting Style ..... Cushion Modified Brilliant  
 Measurements ..... 3.78 x 3.42 x 2.64 mm

Carat Weight ..... 0.34 carat  
 Color Grade ..... Fancy Deep Orangy Yellow  
 Color Origin ..... Natural  
 Color Distribution ..... Even  
 Clarity Grade ..... VS1  
 Proportions:

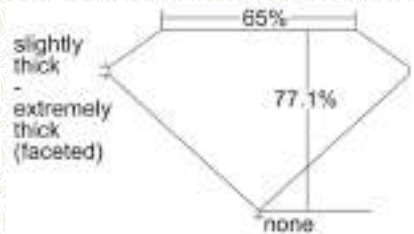

Profile not to actual proportions

Polish ..... Good  
 Symmetry ..... Good  
 Fluorescence ..... None  
 Inscription(s): GIA 2171729289

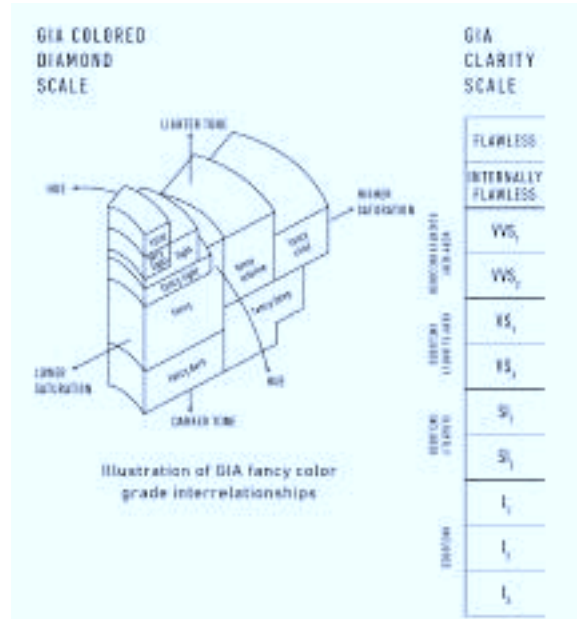
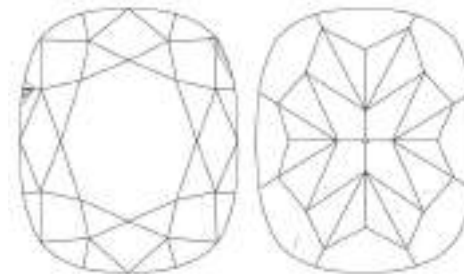
**ADDITIONAL INFORMATION**

**CLARITY CHARACTERISTICS**

**KEY TO SYMBOLS\***

- ◀ Indented Natural    ▲ Extra Facet
- ⚡ Needle
- Pinpoint
- ◊ Natural

\* Red symbols denote internal characteristics (inclusions). Green or black symbols denote external characteristics (blemishes). Diagram is an approximate representation of the diamond, and symbols shown indicate type, position, and approximate size of clarity characteristics. All clarity characteristics may not be shown. Details of finish are not shown.

[reportcheck.gia.edu](http://reportcheck.gia.edu)

The results documented in this report refer only to the diamond described, and were obtained using the techniques and equipment used by GIA at the time of examination. This report is not a guarantee or valuation. For additional information and important limitations and disclaimers, please see [www.gia.edu/terms](http://www.gia.edu/terms) or call +1 800 421 7250 or +1 760 603 4500. ©2014 Gemological Institute of America, Inc.

 THE SECURITY FEATURES IN THIS DOCUMENT, INCLUDING THE HOLOGRAM, SECURITY SCREEN AND MICROPRINT LINES, IN ADDITION TO THOSE NOT LISTED, EXCEED DOCUMENT SECURITY INDUSTRY GUIDELINES.



GIA REPORT  
5171729509

Verify this report at [gia.edu](http://gia.edu)

**FACSIMILE**

This is a digital representation of the original GIA Report. This representation might not be accepted in lieu of the original GIA Report in certain circumstances. The original GIA Report includes certain security features which are not reproducible on this facsimile.

GIA COLORED DIAMOND REPORT

July 18, 2016  
 Report Type .....Grading Report  
 GIA Report Number ..... 5171729509  
 Shape and Cutting Style . Round-Cornered Rectangular  
 Modified Brilliant  
 Measurements ..... 3.86 x 3.20 x 2.44 mm  
 Carat Weight ..... 0.29 carat  
 Color Grade ..... Fancy Intense Orange-Yellow  
 Color Origin ..... Natural  
 Color Distribution ..... Even  
 Clarity Grade ..... SI1  
 Proportions:

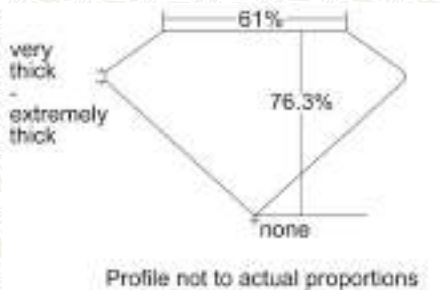

Polish ..... Very Good  
 Symmetry ..... Good  
 Fluorescence ..... None  
 Inscription(s): GIA 5171729509  
**Comments:** Additional clouds are not shown.

ADDITIONAL INFORMATION

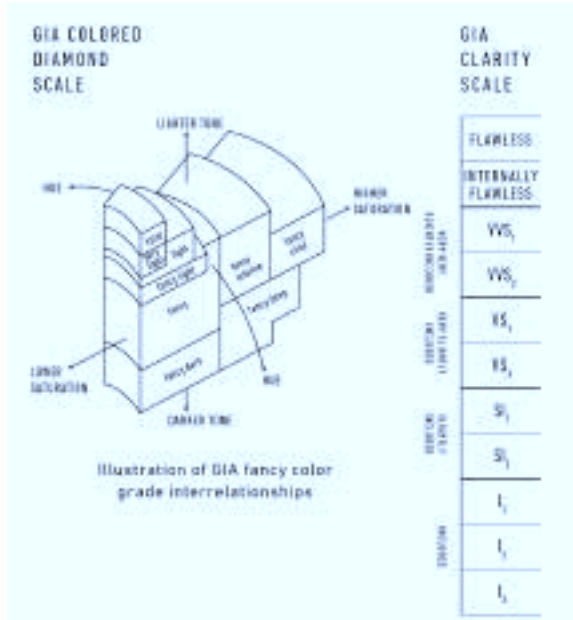

CLARITY CHARACTERISTICS

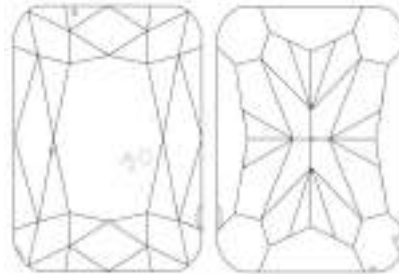

KEY TO SYMBOLS\*

- ↖ Indented Natural
- ◐ Crystal
- ☁ Cloud
- Pinpoint

\* Red symbols denote internal characteristics (inclusions). Green or black symbols denote external characteristics (blemishes). Diagram is an approximate representation of the diamond, and symbols shown indicate type, position, and approximate size of clarity characteristics. All clarity characteristics may not be shown. Details of finish are not shown.



The results documented in this report refer only to the diamond described, and were obtained using the techniques and equipment used by GIA at the time of examination. This report is not a guarantee or valuation. For additional information and important limitations and disclaimers, please see [www.gia.edu/terms](http://www.gia.edu/terms) or call +1 800 421 7250 or +1 760 603 4500. ©2014 Gemological Institute of America, Inc.

[reportcheck.gia.edu](http://reportcheck.gia.edu)



THE SECURITY FEATURES IN THIS DOCUMENT, INCLUDING THE HOLOGRAM, SECURITY SCREEN AND MICROPRINT LINES, IN ADDITION TO THOSE NOT LISTED, EXCEED DOCUMENT SECURITY INDUSTRY GUIDELINES.

**GIA COLORED DIAMOND REPORT**

July 19, 2016  
 Report Type ..... Grading Report  
 GIA Report Number ..... 5171729909  
 Shape and Cutting Style ..... Round-Cornered Square  
 Modified Brilliant  
 Measurements ..... 3.45 x 3.35 x 2.83 mm  
  
 Carat Weight ..... 0.31 carat  
 Color Grade ..... Fancy Deep Yellow-Orange  
 Color Origin ..... Natural  
 Color Distribution ..... Even  
 Clarity Grade ..... SI1  
 Proportions:

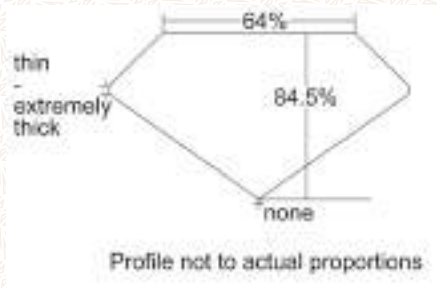

Polish ..... Good  
 Symmetry ..... Fair  
 Fluorescence ..... None  
 Inscription(s): GIA 5171729909

**ADDITIONAL INFORMATION**

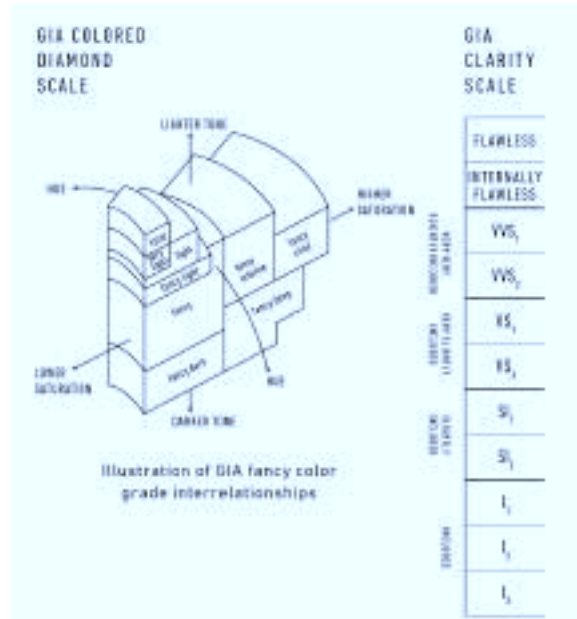

**CLARITY CHARACTERISTICS**

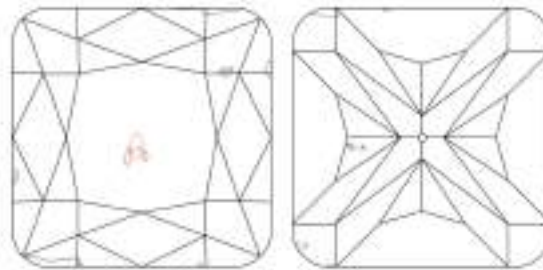

**KEY TO SYMBOLS\***

-  Crystal
-  Natural
-  Indented Natural
-  Extra Facet
-  Cloud
-  Needle

\* Red symbols denote internal characteristics (inclusions). Green or black symbols denote external characteristics (blemishes). Diagram is an approximate representation of the diamond, and symbols shown indicate type, position, and approximate size of clarity characteristics. All clarity characteristics may not be shown. Details of finish are not shown.



The results documented in this report refer only to the diamond described, and were obtained using the techniques and equipment used by GIA at the time of examination. This report is not a guarantee or valuation. For additional information and important limitations and disclaimers, please see [www.gia.edu/terms](http://www.gia.edu/terms) or call +1 800 421 7250 or +1 760 603 4500. ©2014 Gemological Institute of America, Inc.

[reportcheck.gia.edu](http://reportcheck.gia.edu)

