

GIA COLORED DIAMOND REPORT

August 27, 2015
 Report Type Grading Report
 GIA Report Number 1208542979
 Shape and Cutting Style . Round-Cornered Rectangular
 Modified Brilliant
 Measurements 4.70 x 4.07 x 2.90 mm

 Carat Weight 0.51 carat
 Color Grade Fancy Brown-Pink
 Color Origin Natural
 Color Distribution Even
 Clarity Grade I1
 Proportions:

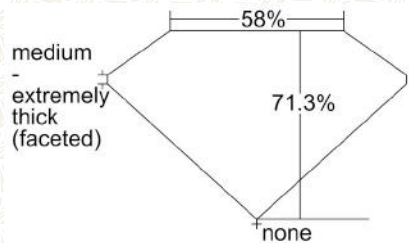



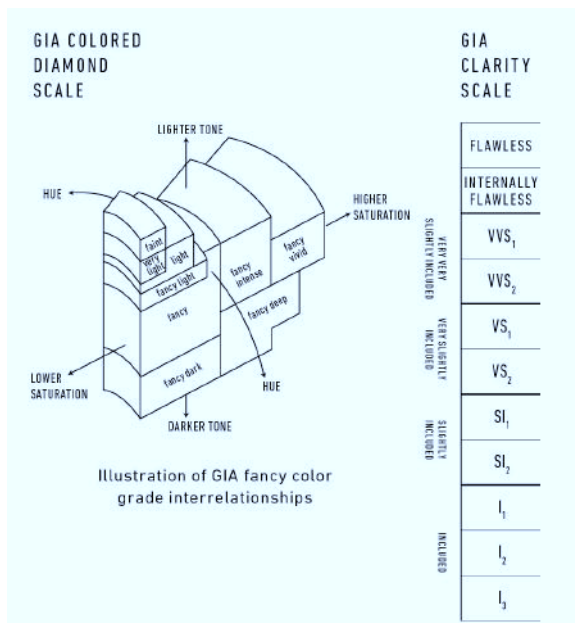
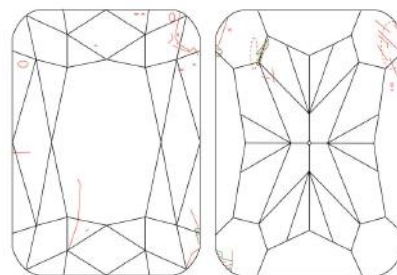

Profile not to actual proportions

Polish Excellent
 Symmetry Good
 Fluorescence None
 Inscription(s): GIA 1208542979

Comments: Additional clouds, pinpoints, internal graining and surface graining are not shown.

ADDITIONAL INFORMATION

CLARITY CHARACTERISTICS

KEY TO SYMBOLS*

-  Feather
-  Crystal
-  Cavity
-  Cloud
-  Needle

* Red symbols denote internal characteristics (inclusions). Green or black symbols denote external characteristics (blemishes). Diagram is an approximate representation of the diamond, and symbols shown indicate type, position, and approximate size of clarity characteristics. All clarity characteristics may not be shown. Details of finish are not shown.



The results documented in this report refer only to the diamond described, and were obtained using the techniques and equipment used by GIA at the time of examination. This report is not a guarantee or valuation. For additional information and important limitations and disclaimers, please see www.gia.edu/terms or call +1 800 421 7250 or +1 760 603 4500. ©2014 Gemological Institute of America, Inc.

reportcheck.gia.edu

 THE SECURITY FEATURES IN THIS DOCUMENT, INCLUDING THE HOLOGRAM, SECURITY SCREEN AND MICROPRINT LINES, IN ADDITION TO THOSE NOT LISTED, EXCEED DOCUMENT SECURITY INDUSTRY GUIDELINES.

GIA COLORED DIAMOND REPORT

March 03, 2016
 Report Type Grading Report
 GIA Report Number 1213644994
 Shape and Cutting Style Heart Modified Brilliant
 Measurements 4.75 x 6.31 x 3.06 mm

Carat Weight 0.63 carat
 Color Grade Fancy Brownish Orangi Pink
 Color Origin Natural
 Color Distribution Even
 Clarity Grade I1
 Proportions:

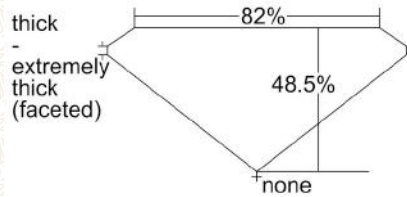

Profile not to actual proportions

Polish Very Good
 Symmetry Fair
 Fluorescence None
 Inscription(s): GIA 1213644994

Comments: Internal graining is not shown. Surface graining is not shown.

ADDITIONAL INFORMATION

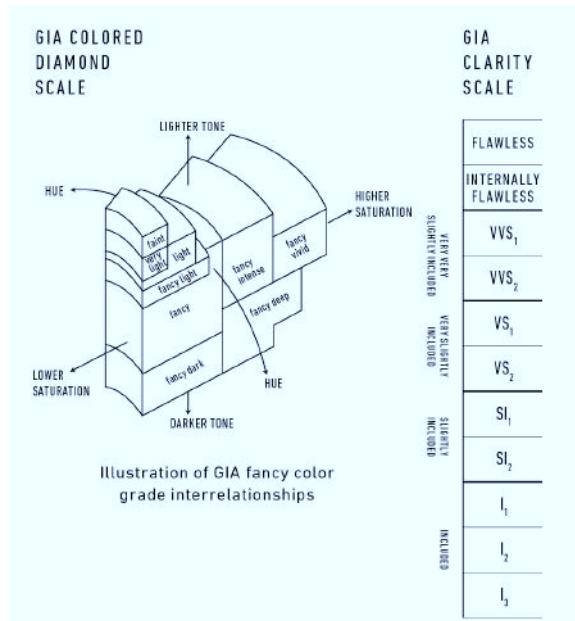

CLARITY CHARACTERISTICS

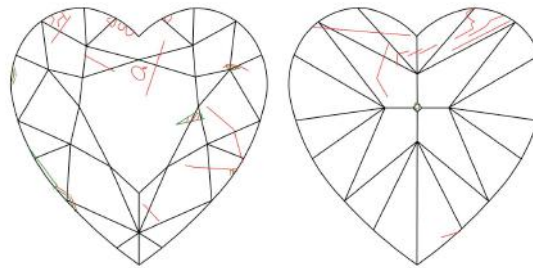

KEY TO SYMBOLS*

- Feather
- Indented Natural
- Crystal
- Natural
- Cavity
- Chip

* Red symbols denote internal characteristics (inclusions). Green or black symbols denote external characteristics (blemishes). Diagram is an approximate representation of the diamond, and symbols shown indicate type, position, and approximate size of clarity characteristics. All clarity characteristics may not be shown. Details of finish are not shown.



reportcheck.gia.edu



The results documented in this report refer only to the diamond described, and were obtained using the techniques and equipment used by GIA at the time of examination. This report is not a guarantee or valuation. For additional information and important limitations and disclaimers, please see www.gia.edu/terms or call +1 800 421 7250 or +1 760 603 4500. ©2014 Gemological Institute of America, Inc.

THE SECURITY FEATURES IN THIS DOCUMENT, INCLUDING THE HOLOGRAM, SECURITY SCREEN AND MICROPRINT LINES, IN ADDITION TO THOSE NOT LISTED, EXCEED DOCUMENT SECURITY INDUSTRY GUIDELINES.

GIA COLORED DIAMOND REPORT

April 06, 2016
 Report Type Grading Report
 GIA Report Number 2175563056
 Shape and Cutting Style Heart Modified Brilliant
 Measurements 4.70 x 5.18 x 3.34 mm

Carat Weight 0.58 carat
 Color Grade Fancy Pink-Brown
 Color Origin Natural
 Color Distribution Even
 Clarity Grade SI2
 Proportions:

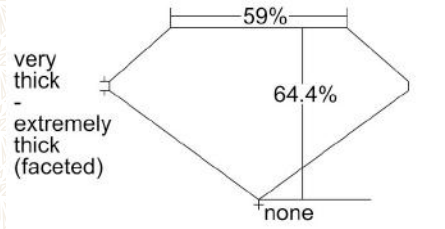

Profile not to actual proportions

Polish Very Good
 Symmetry Good
 Fluorescence Medium Blue
 Inscription(s): GIA 2175563056

Comments: Clouds are not shown. Pinpoints are not shown.

ADDITIONAL INFORMATION

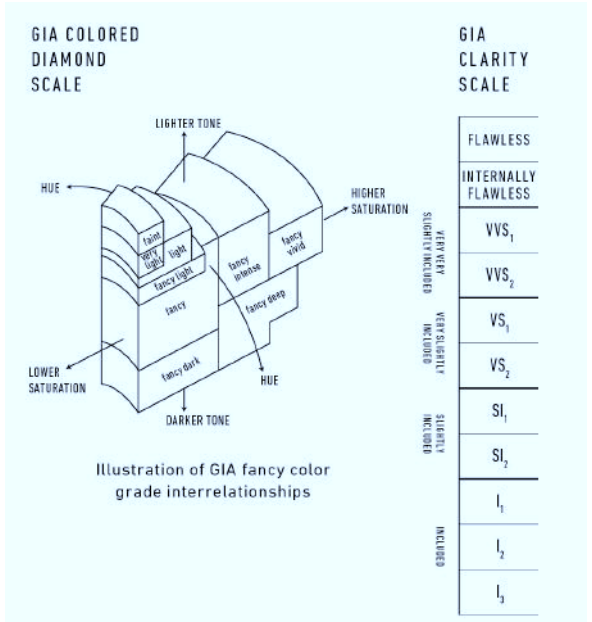

CLARITY CHARACTERISTICS

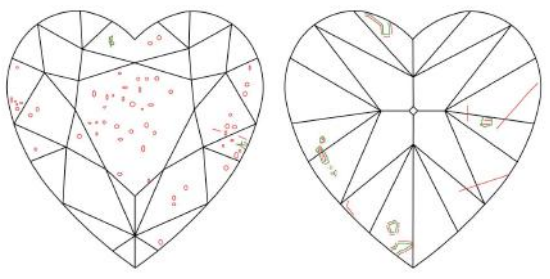

KEY TO SYMBOLS*

- Crystal
- ~ Feather
- ◊ Cavity
- ^ Indented Natural

* Red symbols denote internal characteristics (inclusions). Green or black symbols denote external characteristics (blemishes). Diagram is an approximate representation of the diamond, and symbols shown indicate type, position, and approximate size of clarity characteristics. All clarity characteristics may not be shown. Details of finish are not shown.



The results documented in this report refer only to the diamond described, and were obtained using the techniques and equipment used by GIA at the time of examination. This report is not a guarantee or valuation. For additional information and important limitations and disclaimers, please see www.gia.edu/terms or call +1 800 421 7250 or +1 760 603 4500. ©2014 Gemological Institute of America, Inc.

reportcheck.gia.edu



 THE SECURITY FEATURES IN THIS DOCUMENT, INCLUDING THE HOLOGRAM, SECURITY SCREEN AND MICROPRINT LINES, IN ADDITION TO THOSE NOT LISTED, EXCEED DOCUMENT SECURITY INDUSTRY GUIDELINES.

GIA COLORED DIAMOND REPORT

May 16, 2014
 Report TypeGrading Report
 GIA Report Number 2176200980
 Shape and Cutting Style Cut-Cornered Rectangular Modified Brilliant
 Measurements 4.44 x 3.92 x 3.22 mm

 Carat Weight 0.52 carat
 Color Grade Fancy Brownish Pink
 Color Origin Natural
 Color Distribution Even
 Clarity Grade SI2
 Proportions:

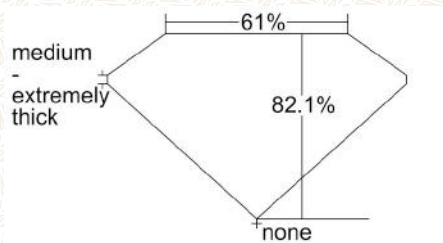

Profile not to actual proportions

Polish Very Good
 Symmetry Very Good
 Fluorescence None

Comments: Clouds, pinpoints, internal graining and surface graining are not shown.

ADDITIONAL INFORMATION

CLARITY CHARACTERISTICS

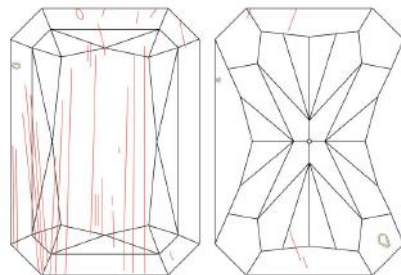

KEY TO SYMBOLS*

-  Feather
-  Crystal
-  Needle
-  Indented Natural

* Red symbols denote internal characteristics (inclusions). Green or black symbols denote external characteristics (blemishes). Diagram is an approximate representation of the diamond, and symbols shown indicate type, position, and approximate size of clarity characteristics. All clarity characteristics may not be shown. Details of finish are not shown.

GIA COLORED DIAMOND SCALE

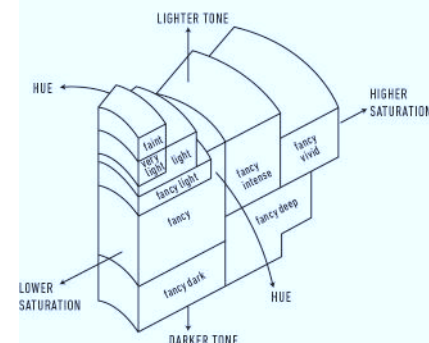

Illustration of GIA fancy color grade interrelationships

GIA CLARITY SCALE

FLAWLESS
INTERNALLY FLAWLESS
VERY VERY SLIGHTLY INCLUDED VVS ₁
VVS ₂
VERY SLIGHTLY INCLUDED VS ₁
VS ₂
SLIGHTLY INCLUDED SI ₁
SI ₂
INCLUDED I ₁
I ₂
I ₃



The results documented in this report refer only to the diamond described, and were obtained using the techniques and equipment used by GIA at the time of examination. This report is not a guarantee or valuation. For additional information and important limitations and disclaimers, please see www.gia.edu/terms or call +1 800 421 7250 or +1 760 603 4500.
 ©2014 Gemological Institute of America, Inc.

reportcheck.gia.edu



 THE SECURITY FEATURES IN THIS DOCUMENT, INCLUDING THE HOLOGRAM, SECURITY SCREEN AND MICROPRINT LINES, IN ADDITION TO THOSE NOT LISTED, EXCEED DOCUMENT SECURITY INDUSTRY GUIDELINES.

GIA COLORED DIAMOND REPORT

July 05, 2014

Report Type Grading Report

GIA Report Number 2176518548

Shape and Cutting Style . Round-Cornered Rectangular
Modified Brilliant

Measurements 4.98 x 3.59 x 2.84 mm

Carat Weight 0.50 carat

Color Grade Fancy Dark Brown-Pink

Color Origin Natural

Color Distribution Even

Clarity Grade I1

Proportions:

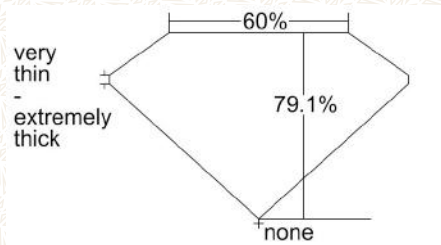

Profile not to actual proportions

Polish Very Good





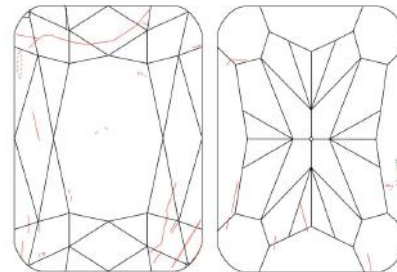

Symmetry Good

Fluorescence None

Inscription(s): GIA 2176518548

Comments: Additional clouds, pinpoints, internal graining and surface graining are not shown.

ADDITIONAL INFORMATION
CLARITY CHARACTERISTICS

KEY TO SYMBOLS*

-  Feather
-  Cavity
-  Crystal
-  Cloud
-  Needle
-  Extra Facet

* Red symbols denote internal characteristics (inclusions). Green or black symbols denote external characteristics (blemishes). Diagram is an approximate representation of the diamond, and symbols shown indicate type, position, and approximate size of clarity characteristics. All clarity characteristics may not be shown. Details of finish are not shown.

GIA COLORED DIAMOND SCALE

Illustration of GIA fancy color grade interrelationships

GIA CLARITY SCALE

	FLAWLESS
	INTERNALLY FLAWLESS
VERY VERY SLIGHTLY INCLUDED	VVS ₁
	VVS ₂
VERY SLIGHTLY INCLUDED	VS ₁
	VS ₂
SLIGHTLY INCLUDED	S ₁
	S ₂
INCLUDED	I ₁
	I ₂
	I ₃

reportcheck.gia.edu

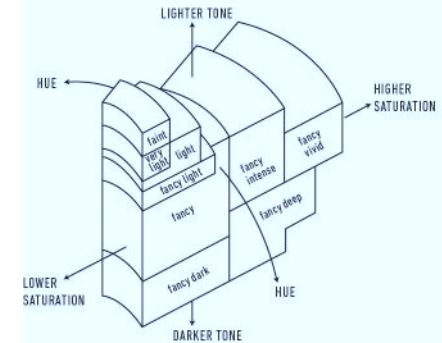
The results documented in this report refer only to the diamond described, and were obtained using the techniques and equipment used by GIA at the time of examination. This report is not a guarantee or valuation. For additional information and important limitations and disclaimers, please see www.gia.edu/terms or call +1 800 421 7250 or +1 760 603 4500. ©2014 Gemological Institute of America, Inc.



THE SECURITY FEATURES IN THIS DOCUMENT, INCLUDING THE HOLOGRAM, SECURITY SCREEN AND MICROPRINT LINES, IN ADDITION TO THOSE NOT LISTED, EXCEED DOCUMENT SECURITY INDUSTRY GUIDELINES.

GIA COLORED DIAMOND REPORT

August 22, 2015
 Report Type Grading Report
 GIA Report Number 2206533542
 Shape and Cutting Style . Modified Rectangular Brilliant
 Measurements 4.66 x 4.15 x 2.94 mm

 Carat Weight 0.52 carat
 Color Grade Fancy Brown-Pink
 Color Origin Natural
 Color Distribution Even
 Clarity Grade I1
 Proportions:

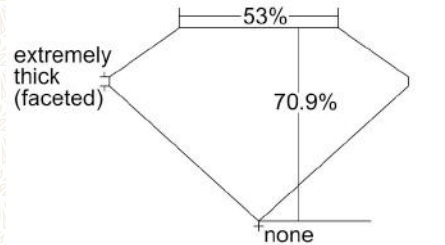

Profile not to actual proportions

Polish Good
 Symmetry Good
 Fluorescence None

Comments: Clouds, pinpoints, internal graining and surface graining are not shown.

ADDITIONAL INFORMATION

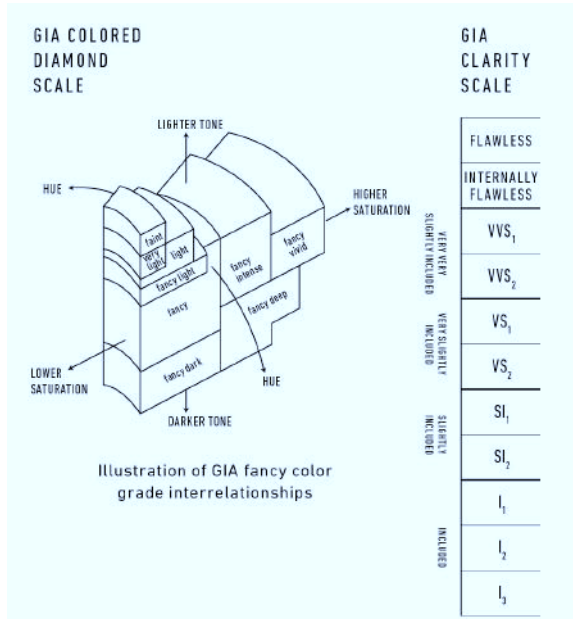

CLARITY CHARACTERISTICS

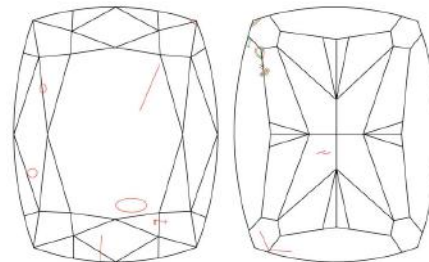

KEY TO SYMBOLS*

- Crystal
- △ Natural
- ~ Feather
- ∖ Needle
- ⋈ Indented Natural

* Red symbols denote internal characteristics (inclusions). Green or black symbols denote external characteristics (blemishes). Diagram is an approximate representation of the diamond, and symbols shown indicate type, position, and approximate size of clarity characteristics. All clarity characteristics may not be shown. Details of finish are not shown.



reportcheck.gia.edu



The results documented in this report refer only to the diamond described, and were obtained using the techniques and equipment used by GIA at the time of examination. This report is not a guarantee or valuation. For additional information and important limitations and disclaimers, please see www.gia.edu/terms or call +1 800 421 7250 or +1 760 603 4500. ©2014 Gemological Institute of America, Inc.

 THE SECURITY FEATURES IN THIS DOCUMENT, INCLUDING THE HOLOGRAM, SECURITY SCREEN AND MICROPRINT LINES, IN ADDITION TO THOSE NOT LISTED, EXCEED DOCUMENT SECURITY INDUSTRY GUIDELINES.

Verify this report at gia.edu

GIA COLORED DIAMOND REPORT

January 27, 2016
 Report Type Identification and Origin Report
 GIA Report Number 5171457531
 Shape and Cutting Style Oval Modified Brilliant
 Measurements 5.17 x 4.10 x 3.16 mm
 Carat Weight 0.60 carat
 Color Grade Fancy Brownish Purplish Pink
 Color Origin Natural
 Color Distribution Even
 Inscription(s): GIA 5171457531

ADDITIONAL INFORMATION

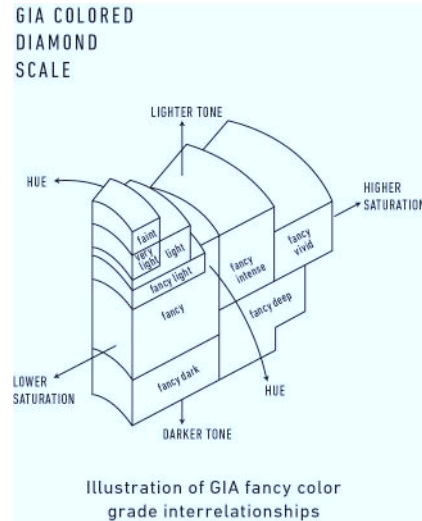

The results documented in this report refer only to the diamond described, and were obtained using the techniques and equipment used by GIA at the time of examination. This report is not a guarantee or valuation. For additional information and important limitations and disclaimers, please see www.gia.edu/terms or call +1 800 421 7250 or +1 760 603 4500. ©2014 Gemological Institute of America, Inc.

reportcheck.gia.edu

