

GIA NATURAL COLORED DIAMOND REPORT

May 13, 2019
 Report Type Grading Report
 GIA Report Number 6203281000
 Shape and Cutting Style Oval Modified Brilliant
 Measurements 6.70 x 4.87 x 2.82 mm

Carat Weight 0.67 carat
 Color Grade Fancy Brownish Pink
 Color Origin Natural
 Color Distribution Even
 Clarity Grade SI1
 Proportions:

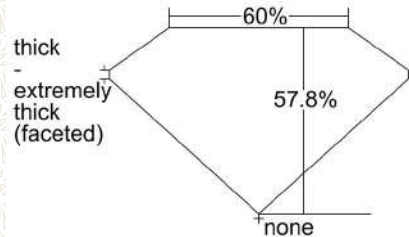

Profile not to actual proportions

Polish Very Good
 Symmetry Good
 Fluorescence None

Comments: Internal graining is not shown. Surface graining is not shown.

ADDITIONAL INFORMATION

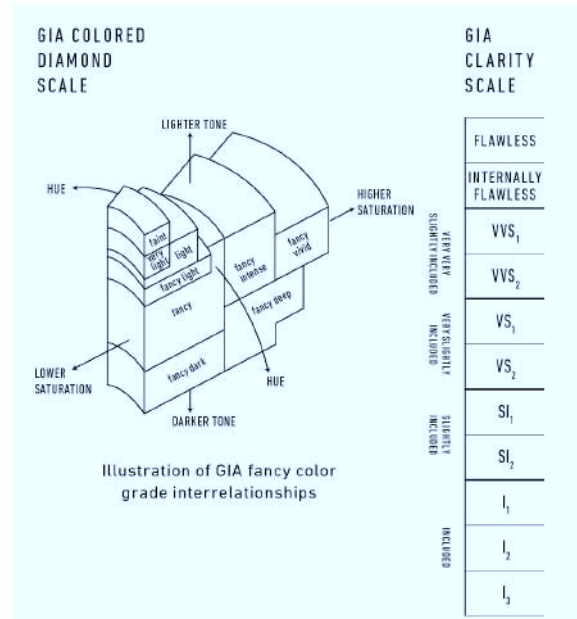

CLARITY CHARACTERISTICS

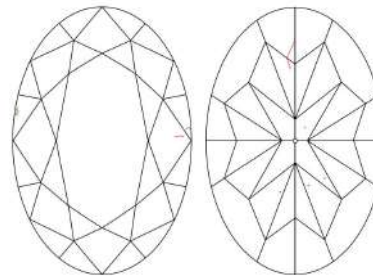

KEY TO SYMBOLS*

-  Feather
-  Indented Natural
-  Pinpoint

* Red symbols denote internal characteristics (inclusions). Green or black symbols denote external characteristics (blemishes). Diagram is an approximate representation of the diamond, and symbols shown indicate type, position, and approximate size of clarity characteristics. All clarity characteristics may not be shown. Details of finish are not shown.



reportcheck.gia.edu



The results documented in this report refer only to the diamond described, and were obtained using the techniques and equipment available to GIA at the time of examination. This report is not a guarantee or valuation. For additional information and important limitations and disclaimers, please see GIA.edu/terms or call +1 800 421 7250 or +1 760 603 4500. ©2017 Gemological Institute of America, Inc.

 THE SECURITY FEATURES IN THIS DOCUMENT, INCLUDING THE HOLOGRAM, SECURITY SCREEN AND MICROPRINT LINES, IN ADDITION TO THOSE NOT LISTED, EXCEED DOCUMENT SECURITY INDUSTRY GUIDELINES.

GIA NATURAL COLORED DIAMOND REPORT

January 29, 2020
 Report Type Grading Report
 GIA Report Number 6204809178
 Shape and Cutting Style Round Brilliant
 Measurements 4.62 - 4.63 x 2.95 mm

Carat Weight 0.40 carat
 Color Grade Faint Yellow-Green
 Color Origin Natural
 Color Distribution Not Applicable
 Clarity Grade SI2
 Proportions:

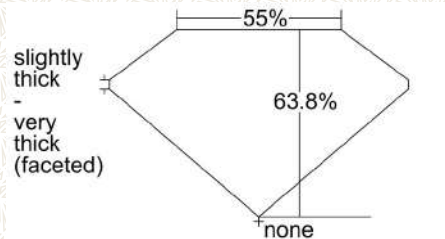

Profile not to actual proportions

Polish Very Good
 Symmetry Good
 Fluorescence Strong Blue

Comments: Patches of color are not shown. Surface graining is not shown.

ADDITIONAL INFORMATION

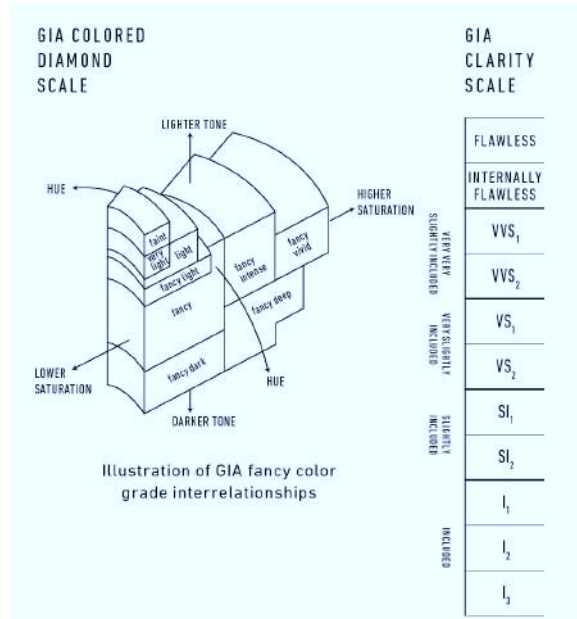

CLARITY CHARACTERISTICS

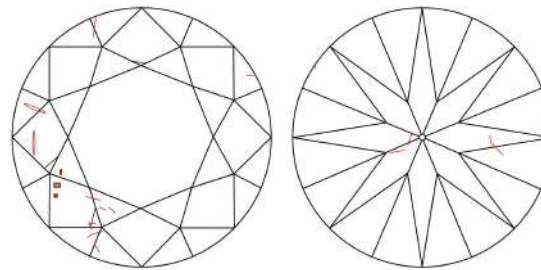

KEY TO SYMBOLS*

- Crystal
- ~ Feather
- Etch Channel
- △ Extra Facet

* Red symbols denote internal characteristics (inclusions). Green or black symbols denote external characteristics (blemishes). Diagram is an approximate representation of the diamond, and symbols shown indicate type, position, and approximate size of clarity characteristics. All clarity characteristics may not be shown. Details of finish are not shown.



reportcheck.gia.edu



The results documented in this report refer only to the diamond described, and were obtained using the techniques and equipment available to GIA at the time of examination. This report is not a guarantee or valuation. For additional information and important limitations and disclaimers, please see GIA.edu/terms or call +1 800 421 7250 or +1 760 603 4500. ©2017 Gemological Institute of America, Inc.

 THE SECURITY FEATURES IN THIS DOCUMENT, INCLUDING THE HOLOGRAM, SECURITY SCREEN AND MICROPRINT LINES, IN ADDITION TO THOSE NOT LISTED, EXCEED DOCUMENT SECURITY INDUSTRY GUIDELINES.

GIA COLORED DIAMOND REPORT

November 23, 2015
 Report Type Grading Report
 GIA Report Number 6177399509
 Shape and Cutting Style Pear Brilliant
 Measurements 6.96 x 4.34 x 2.26 mm

Carat Weight 0.42 carat
 Color Grade Fancy Yellow
 Color Origin Natural
 Color Distribution Even
 Clarity Grade I1
 Proportions:

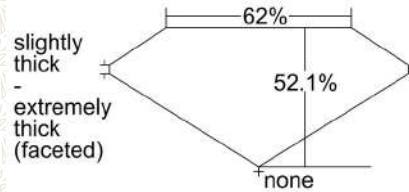

Profile not to actual proportions

Polish Very Good
 Symmetry Good
 Fluorescence None

ADDITIONAL INFORMATION

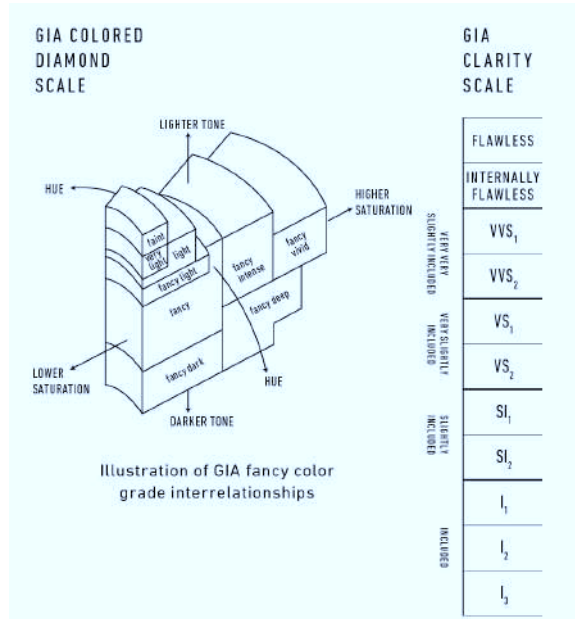

CLARITY CHARACTERISTICS

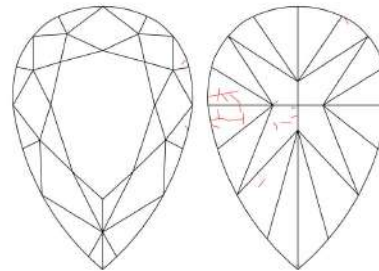

KEY TO SYMBOLS*

-  Feather
-  Natural

* Red symbols denote internal characteristics (inclusions). Green or black symbols denote external characteristics (blemishes). Diagram is an approximate representation of the diamond, and symbols shown indicate type, position, and approximate size of clarity characteristics. All clarity characteristics may not be shown. Details of finish are not shown.



reportcheck.gia.edu



The results documented in this report refer only to the diamond described, and were obtained using the techniques and equipment used by GIA at the time of examination. This report is not a guarantee or valuation. For additional information and important limitations and disclaimers, please see www.gia.edu/terms or call +1 800 421 7250 or +1 760 603 4500. ©2014 Gemological Institute of America, Inc.

 THE SECURITY FEATURES IN THIS DOCUMENT, INCLUDING THE HOLOGRAM, SECURITY SCREEN AND MICROPRINT LINES, IN ADDITION TO THOSE NOT LISTED, EXCEED DOCUMENT SECURITY INDUSTRY GUIDELINES.



GIA
GEMOLOGICAL INSTITUTE OF AMERICA®

COLORED DIAMOND GRADING REPORT

GIA REPORT 1146345442

January 27, 2012

Shape and Cutting Style **Round Brilliant**
Measurements 5.17 - 5.19 x 3.02 mm

GRADING RESULTS

Carat Weight **0.50 carat**
Color **NATURAL**
Origin **FANCY**
Grade **BROWNISH GREENISH YELLOW**
Distribution **Even**
Clarity Grade **VS1**

ADDITIONAL GRADING INFORMATION

Finish
Polish **Very Good**
Symmetry **Very Good**
Fluorescence **Faint**
Comments:
Additional clouds, additional pinpoints and surface graining are not shown.

REFERENCE DIAGRAMS

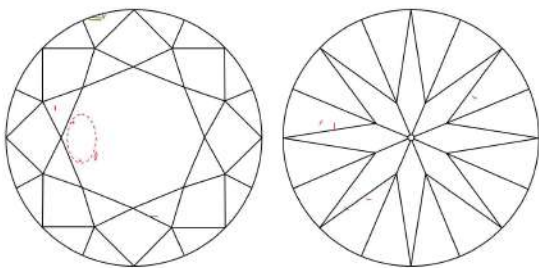

KEY TO SYMBOLS

- Crystal
- ~ Feather
- Pinpoint
- ☉ Cloud
- ▲ Indented Natural

Red symbols denote internal characteristics (inclusions). Green or black symbols denote external characteristics (blemishes). Diagram is an approximate representation of the diamond, and symbols shown indicate type, position, and approximate size of clarity characteristics. All clarity characteristics may not be shown. Details of finish are not shown.

Facsimile

5355 Armada Drive | Carlsbad, CA 92008-4602
T: 760-603-4500 | F: 760-603-1814

GIA Laboratories
Bangkok Carlsbad Gaborone
Johannesburg Mumbai New York

www.gia.edu

GIA CLARITY SCALE	
FLAWLESS	
INTERNALLY FLAWLESS	
VERY VERY SLIGHTLY INCLUDED	VVS ₁
	VVS ₂
VERY SLIGHTLY INCLUDED	VS ₁
	VS ₂
SLIGHTLY INCLUDED	S ₁
	S ₂
	I ₁
	I ₂
	I ₃

GIA COLORED DIAMOND SCALE

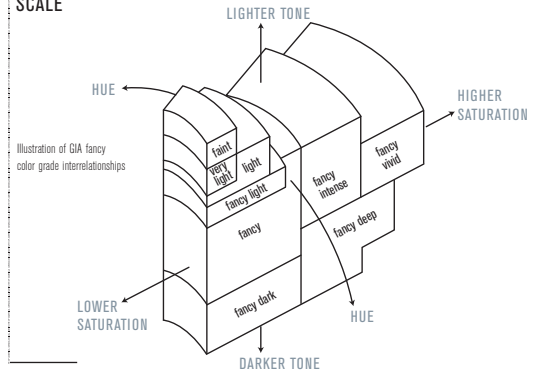

210115130479

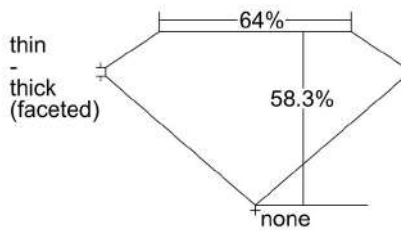

Profile not to actual proportions

This is a digital representation of the original GIA Report. To verify the information herein, please refer to reportcheck.gia.edu. This Report is not a guarantee, valuation or appraisal and contains only the characteristics of the diamond described herein after it has been graded, tested, examined and analyzed by the laboratory providing this Report ("GIA") and/or has been inscribed using the techniques and equipment used by GIA at the time of the examination and/or inscription. Inscriptions reported in this document are not a guarantee, validation, or warranty of a diamond's quality, country of origin or source; or that the diamond will be identifiable by the inscription in the future (since inscriptions can be removed). GIA makes no representation concerning any trademark, word, or symbol which is inscribed by GIA or which is identified on this Report. The recipient of this Report may wish to consult a credentialed jeweler or gemologist about the information contained herein.

For terms, conditions, and limitations, see www.gia.edu/terms or call 800-421-7250 or 760-603-4500.





GIA
GEMOLOGICAL INSTITUTE OF AMERICA®

5355 Armada Drive | Carlsbad, CA 92008-4602
T: 760-603-4500 | F: 760-603-1814

Facsimile

GIA Laboratories
Bangkok Carlsbad Gaborone
Johannesburg Mumbai New York

www.gia.edu

COLORED DIAMOND GRADING REPORT

GIA REPORT 1146866992

August 31, 2012

Shape and Cutting Style **Round-Cornered
Rectangular Modified Brilliant**

Measurements 4.83 x 4.10 x 2.85 mm

GRADING RESULTS

Carat Weight **0.53 carat**

Color

Origin **NATURAL**

Grade **FANCY**

..... **YELLOW**

Distribution **Even**

Clarity Grade **VS1**

ADDITIONAL GRADING INFORMATION

Finish

Polish Good

Symmetry Good

Fluorescence None

Comments:

None

REFERENCE DIAGRAMS

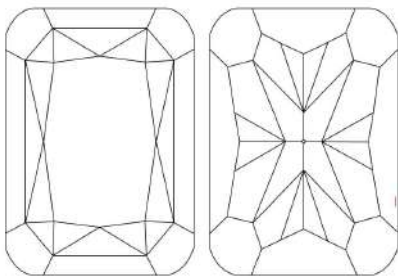

GIA CLARITY SCALE	
FLAWLESS	
INTERNALLY FLAWLESS	
VERY VERY SLIGHTLY INCLUDED	VVS ₁
	VVS ₂
VERY SLIGHTLY INCLUDED	VS ₁
	VS ₂
SLIGHTLY INCLUDED	S ₁
	S ₂
INCLUDED	I ₁
	I ₂
	I ₃

GIA COLORED DIAMOND SCALE

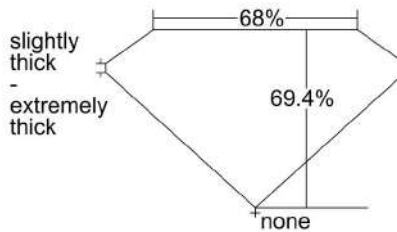
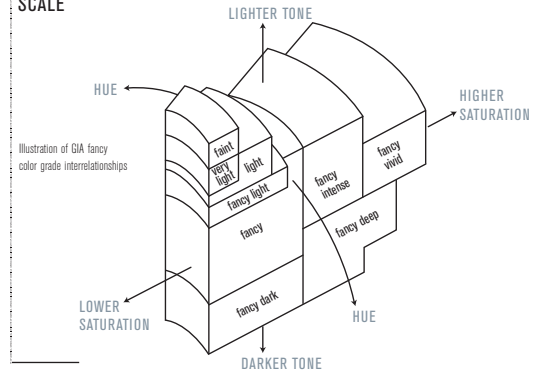

Profile not to actual proportions

KEY TO SYMBOLS

Feather

Red symbols denote internal characteristics (inclusions). Green or black symbols denote external characteristics (blemishes). Diagram is an approximate representation of the diamond, and symbols shown indicate type, position, and approximate size of clarity characteristics. All clarity characteristics may not be shown. Details of finish are not shown.

This is a digital representation of the original GIA Report. To verify the information herein, please refer to reportscheck.gia.edu. This Report is not a guarantee, valuation or appraisal and contains only the characteristics of the diamond described herein after it has been graded, tested, examined and analyzed by the laboratory providing this Report ("GIA") and/or has been inscribed using the techniques and equipment used by GIA at the time of the examination and/or inscription. Inscriptions reported in this document are not a guarantee, validation, or warranty of a diamond's quality, country of origin or source; or that the diamond will be identifiable by the inscription in the future (since inscriptions can be removed). GIA makes no representation concerning any trademark, word, or symbol which is inscribed by GIA or which is identified on this Report. The recipient of this Report may wish to consult a credentialed jeweler or gemologist about the information contained herein.

For terms, conditions, and limitations, see www.gia.edu/terms or call 800-421-7250 or 760-603-4500.



GIA COLORED DIAMOND REPORT

December 08, 2016
 Report Type Grading Report
 GIA Report Number 1248354218
 Shape and Cutting Style Round Brilliant
 Measurements 4.59 - 4.60 x 2.86 mm

Carat Weight 0.37 carat
 Color Grade Faint Pink
 Color Origin Natural
 Color Distribution Not Applicable
 Clarity Grade VVS2
 Proportions:

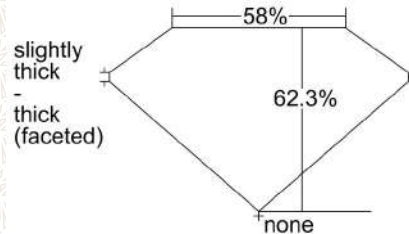

Profile not to actual proportions

Polish Very Good
 Symmetry Very Good
 Fluorescence None

Comments: Clouds, internal graining and surface graining are not shown.

ADDITIONAL INFORMATION

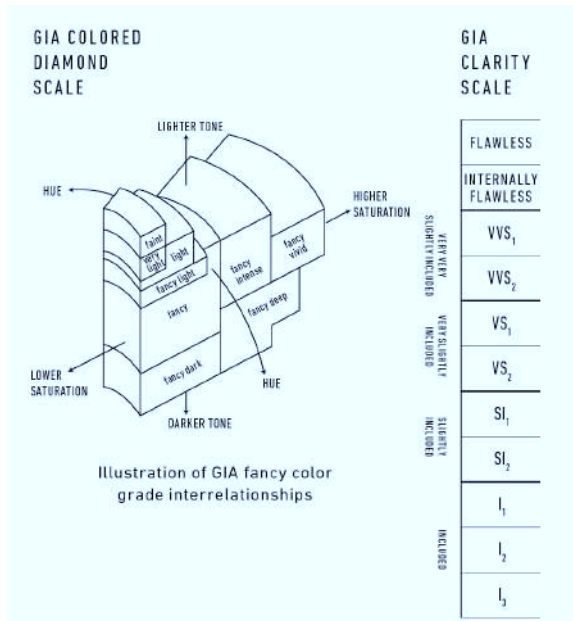
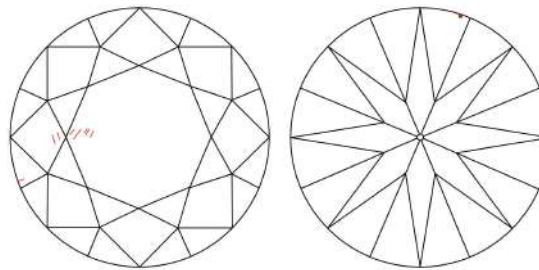

Illustration of GIA fancy color grade interrelationships

CLARITY CHARACTERISTICS



KEY TO SYMBOLS*

- Needle
- Feather
- Etch Channel

* Red symbols denote internal characteristics (inclusions). Green or black symbols denote external characteristics (blemishes). Diagram is an approximate representation of the diamond, and symbols shown indicate type, position, and approximate size of clarity characteristics. All clarity characteristics may not be shown. Details of finish are not shown.



reportcheck.gia.edu



The results documented in this report refer only to the diamond described, and were obtained using the techniques and equipment used by GIA at the time of examination. This report is not a guarantee or valuation. For additional information and important limitations and disclaimers, please see www.gia.edu/terms or call +1 800 421 7250 or +1 760 603 4500. ©2014 Gemological Institute of America, Inc.

 THE SECURITY FEATURES IN THIS DOCUMENT, INCLUDING THE HOLOGRAM, SECURITY SCREEN AND MICROPRINT LINES, IN ADDITION TO THOSE NOT LISTED, EXCEED DOCUMENT SECURITY INDUSTRY GUIDELINES.

GIA COLORED DIAMOND REPORT

December 07, 2016
 Report Type Grading Report
 GIA Report Number 7243353892
 Shape and Cutting Style Round Brilliant
 Measurements 4.78 - 4.80 x 3.08 mm

Carat Weight 0.43 carat
 Color Grade Very Light Pink
 Color Origin Natural
 Color Distribution Not Applicable
 Clarity Grade I2
 Proportions:

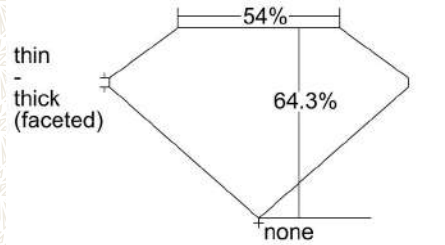

Profile not to actual proportions

Polish Very Good
 Symmetry Very Good
 Fluorescence Faint

Comments: Additional clouds, pinpoints and surface graining are not shown.

ADDITIONAL INFORMATION

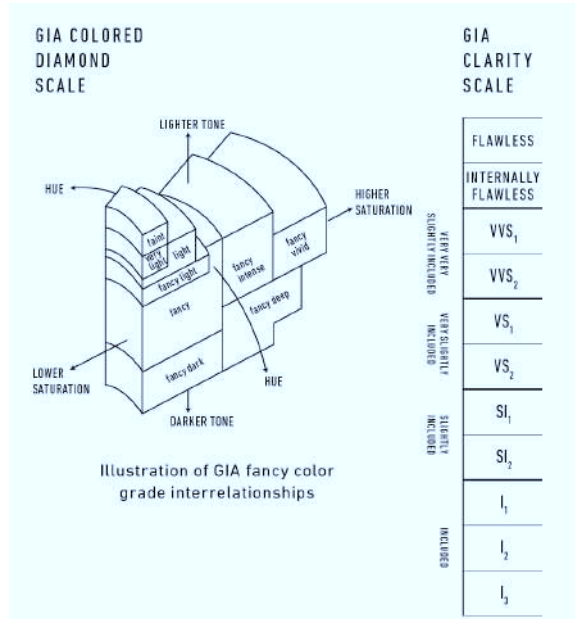

CLARITY CHARACTERISTICS

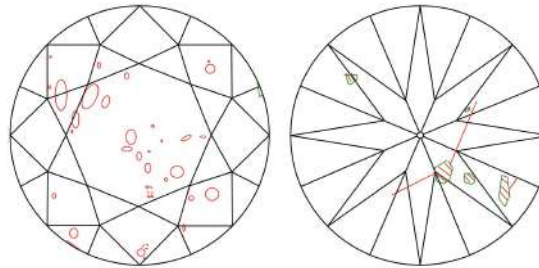

KEY TO SYMBOLS*

- Crystal
- △ Natural
- ◡ Cavity
- ◡ Feather
- ◡ Cloud

* Red symbols denote internal characteristics (inclusions). Green or black symbols denote external characteristics (blemishes). Diagram is an approximate representation of the diamond, and symbols shown indicate type, position, and approximate size of clarity characteristics. All clarity characteristics may not be shown. Details of finish are not shown.



reportcheck.gia.edu



The results documented in this report refer only to the diamond described, and were obtained using the techniques and equipment used by GIA at the time of examination. This report is not a guarantee or valuation. For additional information and important limitations and disclaimers, please see www.gia.edu/terms or call +1 800 421 7250 or +1 760 603 4500. ©2014 Gemological Institute of America, Inc.

THE SECURITY FEATURES IN THIS DOCUMENT, INCLUDING THE HOLOGRAM, SECURITY SCREEN AND MICROPRINT LINES, IN ADDITION TO THOSE NOT LISTED, EXCEED DOCUMENT SECURITY INDUSTRY GUIDELINES.



GIA
GEMOLOGICAL INSTITUTE OF AMERICA®

COLORED DIAMOND GRADING REPORT

GIA REPORT 2141668300

May 23, 2012

Shape and Cutting Style **Cushion Modified Brilliant**

Measurements 4.73 x 4.65 x 2.75 mm

GRADING RESULTS

Carat Weight **0.50 carat**

Color

Origin **NATURAL**

Grade **FANCY LIGHT**

..... **YELLOW**

Distribution **Even**

Clarity Grade **VVS2**

ADDITIONAL GRADING INFORMATION

Finish

Polish **Very Good**

Symmetry **Good**

Fluorescence **Faint**

Comments:

None

REFERENCE DIAGRAMS

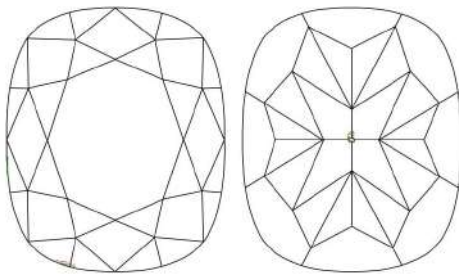

KEY TO SYMBOLS

- Indented Natural
- Cavity
- Natural

Red symbols denote internal characteristics (inclusions). Green or black symbols denote external characteristics (blemishes). Diagram is an approximate representation of the diamond, and symbols shown indicate type, position, and approximate size of clarity characteristics. All clarity characteristics may not be shown. Details of finish are not shown.

Facsimile

5355 Armada Drive | Carlsbad, CA 92008-4602
T: 760-603-4500 | F: 760-603-1814

GIA Laboratories

Bangkok Carlsbad Gaborone
Johannesburg Mumbai New York

www.gia.edu

GIA CLARITY SCALE	
FLAWLESS	VERY VERY SLIGHTLY INCLUDED
INTERNALLY FLAWLESS	
VVS ₁	VERY SLIGHTLY INCLUDED
VVS ₂	
VS ₁	SLIGHTLY INCLUDED
VS ₂	
S ₁	INCLUDED
S ₂	
I ₁	
I ₂	INCLUDED
I ₃	

GIA COLORED DIAMOND SCALE

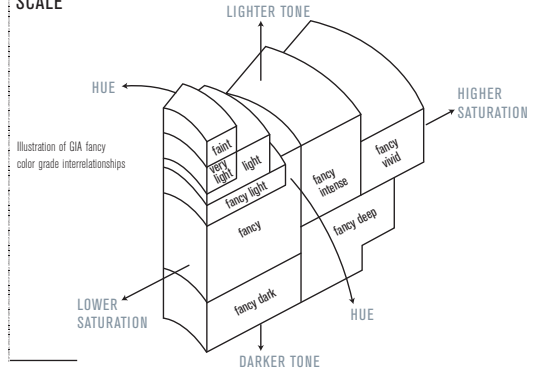

610716585199

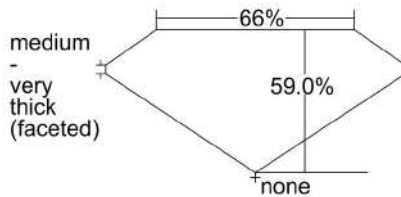

Profile not to actual proportions

This is a digital representation of the original GIA Report. To verify the information herein, please refer to reportcheck.gia.edu. This Report is not a guarantee, valuation or appraisal and contains only the characteristics of the diamond described herein after it has been graded, tested, examined and analyzed by the laboratory providing this Report ("GIA") and/or has been inscribed using the techniques and equipment used by GIA at the time of the examination and/or inscription. Inscriptions reported in this document are not a guarantee, validation, or warranty of a diamond's quality, country of origin or source; or that the diamond will be identifiable by the inscription in the future (since inscriptions can be removed). GIA makes no representation concerning any trademark, word, or symbol which is inscribed by GIA or which is identified on this Report. The recipient of this Report may wish to consult a credentialed jeweler or gemologist about the information contained herein.

For terms, conditions, and limitations, see www.gia.edu/terms or call 800-421-7250 or 760-603-4500.



©2010 GEMOLOGICAL INSTITUTE OF AMERICA, INC.

GIA NATURAL COLORED DIAMOND REPORT

December 01, 2015
 Report Type Grading Report
 GIA Report Number 1176399444
 Shape and Cutting Style Oval Modified Brilliant
 Measurements 6.31 x 4.31 x 2.32 mm

 Carat Weight 0.47 carat
 Color Grade Light Pinkish Brown
 Color Origin Natural
 Color Distribution Not Applicable
 Clarity Grade I1
 Proportions:

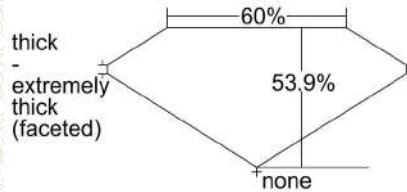

Profile not to actual proportions

Polish Very Good
 Symmetry Good
 Fluorescence None
 Comments: Pinpoints are not shown.

ADDITIONAL INFORMATION

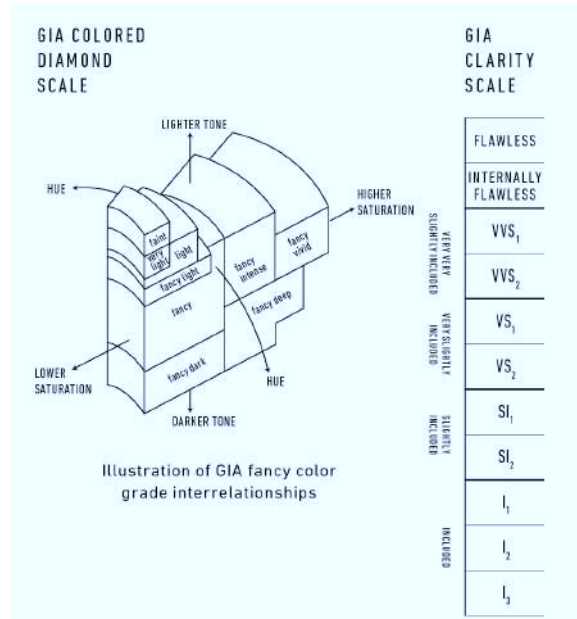

CLARITY CHARACTERISTICS

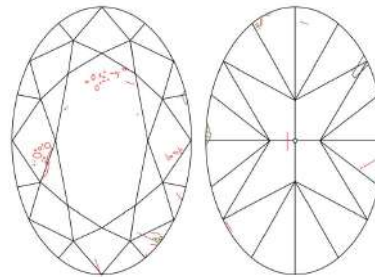

KEY TO SYMBOLS*

- Crystal
- ↘ Needle
- ↗ Feather
- △ Natural
- ◻ Cavity
- △ Extra Facet
- ⊖ Knot

* Red symbols denote internal characteristics (inclusions). Green or black symbols denote external characteristics (blemishes). Diagram is an approximate representation of the diamond, and symbols shown indicate type, position, and approximate size of clarity characteristics. All clarity characteristics may not be shown. Details of finish are not shown.



reportcheck.gia.edu



The results documented in this report refer only to the diamond described, and were obtained using the techniques and equipment available to GIA at the time of examination. This report is not a guarantee or valuation. For additional information and important limitations and disclaimers, please see GIA.edu/terms or call +1 800 421 7250 or +1 760 603 4500. ©2017 Gemological Institute of America, Inc.

THE SECURITY FEATURES IN THIS DOCUMENT, INCLUDING THE HOLOGRAM, SECURITY SCREEN AND MICROPRINT LINES, IN ADDITION TO THOSE NOT LISTED, EXCEED DOCUMENT SECURITY INDUSTRY GUIDELINES.

GIA COLORED DIAMOND REPORT

November 23, 2015
 Report Type Grading Report
 GIA Report Number 1213089125
 Shape and Cutting Style Round Brilliant
 Measurements 4.92 - 4.95 x 3.22 mm

Carat Weight 0.50 carat
 Color Grade Faint Green
 Color Origin Natural
 Color Distribution Not Applicable
 Clarity Grade SI1
 Proportions:

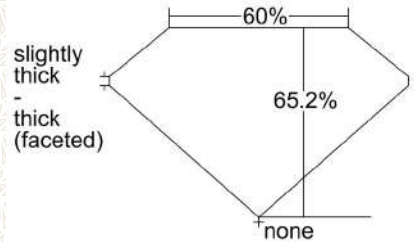

Profile not to actual proportions

Polish Very Good
 Symmetry Very Good
 Fluorescence None

ADDITIONAL INFORMATION

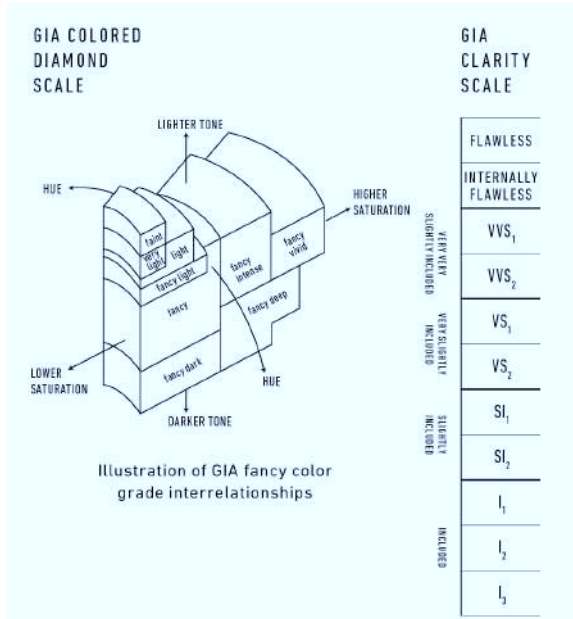

CLARITY CHARACTERISTICS

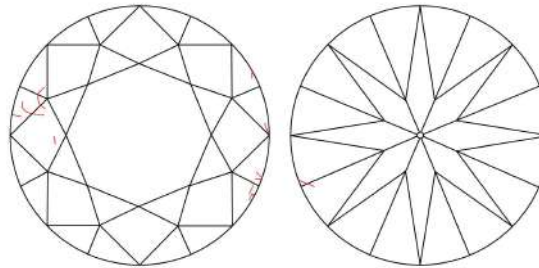

KEY TO SYMBOLS*

 Feather

* Red symbols denote internal characteristics (inclusions). Green or black symbols denote external characteristics (blemishes). Diagram is an approximate representation of the diamond, and symbols shown indicate type, position, and approximate size of clarity characteristics. All clarity characteristics may not be shown. Details of finish are not shown.



reportcheck.gia.edu



The results documented in this report refer only to the diamond described, and were obtained using the techniques and equipment used by GIA at the time of examination. This report is not a guarantee or valuation. For additional information and important limitations and disclaimers, please see www.gia.edu/terms or call +1 800 421 7250 or +1 760 603 4500. ©2014 Gemological Institute of America, Inc.

 THE SECURITY FEATURES IN THIS DOCUMENT, INCLUDING THE HOLOGRAM, SECURITY SCREEN AND MICROPRINT LINES, IN ADDITION TO THOSE NOT LISTED, EXCEED DOCUMENT SECURITY INDUSTRY GUIDELINES.

GIA DIAMOND GRADING REPORT

 July 27, 2015
 GIA Report Number 5172252930
 Shape and Cutting Style Star Mixed Cut
 Measurements 6.61 x 5.97 x 2.25 mm

GRADING RESULTS

 Carat Weight 0.48 carat
 Color Grade E
 Clarity Grade VS1

ADDITIONAL GRADING INFORMATION

 Polish Good
 Symmetry Good
 Fluorescence Faint

Comments: Additional pinpoints are not shown. Surface graining is not shown.

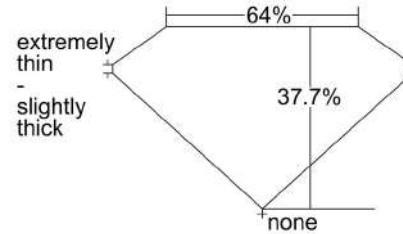
PROPORTIONS

Profile not to actual proportions

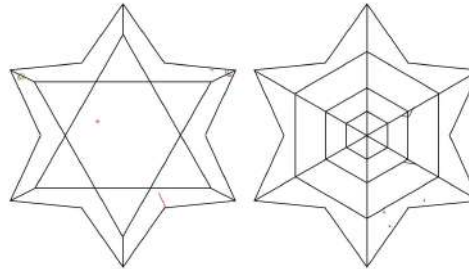
CLARITY CHARACTERISTICS

KEY TO SYMBOLS*

- Crystal
- / Feather
- \ Needle
- ^ Indented Natural
- Pinpoint
- ^ Extra Facet

GRADING SCALES
GIA COLOR SCALE

COLORLESS	D
	E
	F
NEAR COLORLESS	G
	H
	I
FANT	J
	K
	L
VERY LIGHT	M
	N
	O
LIGHT	P
	Q
	R
	S
	T
	U
	V
W	
X	
Y	
Z	

GIA CLARITY SCALE

FLAWLESS	INTERNAL FLAWLESS
VERY VERY SLIGHTLY INCLUDED	VVS ₂
	VERY SLIGHTLY INCLUDED
VS ₂	
SLIGHTLY INCLUDED	SI ₁
	SI ₂
INCLUDED	I ₁
	I ₂
	I ₃

reportcheck.gia.edu

 The results documented in this report refer only to the diamond described, and were obtained using the techniques and equipment used by GIA at the time of examination. This report is not a guarantee or valuation. For additional information and important limitations and disclaimers, please see www.gia.edu/terms or call +1 800 421 7250 or +1 760 603 4500. ©2014 Gemological Institute of America, Inc.

* Red symbols denote internal characteristics (inclusions). Green or black symbols denote external characteristics (blemishes). Diagram is an approximate representation of the diamond, and symbols shown indicate type, position, and approximate size of clarity characteristics. All clarity characteristics may not be shown. Details of finish are not shown.



GIA
GEMOLOGICAL INSTITUTE OF AMERICA®

COLORED DIAMOND GRADING REPORT

GIA REPORT 1146787410

July 25, 2012

Shape and Cutting Style **Cushion Modified Brilliant**

Measurements 4.74 x 4.50 x 3.02 mm

GRADING RESULTS

Carat Weight **0.52 carat**

Color

Origin **NATURAL**

Grade **FANCY**

..... **YELLOW**

Distribution **Even**

Clarity Grade **VS1**

ADDITIONAL GRADING INFORMATION

Finish

Polish **Good**

Symmetry **Good**

Fluorescence **None**

Comments:

None

REFERENCE DIAGRAMS

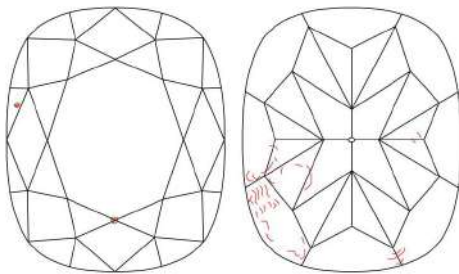

KEY TO SYMBOLS

- Feather
- Cavity

Red symbols denote internal characteristics (inclusions). Green or black symbols denote external characteristics (blemishes). Diagram is an approximate representation of the diamond, and symbols shown indicate type, position, and approximate size of clarity characteristics. All clarity characteristics may not be shown. Details of finish are not shown.

Facsimile

5355 Armada Drive | Carlsbad, CA 92008-4602
T: 760-603-4500 | F: 760-603-1814

GIA Laboratories

Bangkok Carlsbad Gaborone
Johannesburg Mumbai New York

www.gia.edu

GIA CLARITY SCALE	
FLAWLESS	
INTERNALLY FLAWLESS	
VERY VERY SLIGHTLY INCLUDED	VVS ₁
	VVS ₂
VERY SLIGHTLY INCLUDED	VS ₁
	VS ₂
SLIGHTLY INCLUDED	S ₁
	S ₂
	I ₁
	I ₂
	I ₃

GIA COLORED DIAMOND SCALE

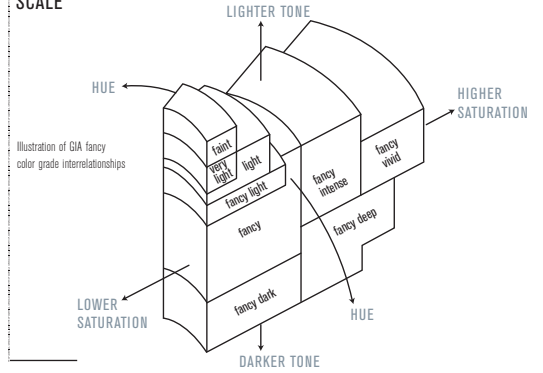

510117410249

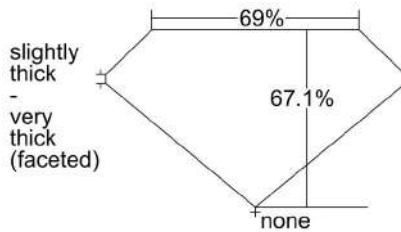

Profile not to actual proportions

This is a digital representation of the original GIA Report. To verify the information herein, please refer to reportcheck.gia.edu. This Report is not a guarantee, valuation or appraisal and contains only the characteristics of the diamond described herein after it has been graded, tested, examined and analyzed by the laboratory providing this Report ("GIA") and/or has been inscribed using the techniques and equipment used by GIA at the time of the examination and/or inscription. Inscriptions reported in this document are not a guarantee, validation, or warranty of a diamond's quality, country of origin or source; or that the diamond will be identifiable by the inscription in the future (since inscriptions can be removed). GIA makes no representation concerning any trademark, word, or symbol which is inscribed by GIA or which is identified on this Report. The recipient of this Report may wish to consult a credentialed jeweler or gemologist about the information contained herein.

For terms, conditions, and limitations, see www.gia.edu/terms or call 800-421-7250 or 760-603-4500.





COLORED DIAMOND GRADING REPORT

GIA REPORT 5131917408

October 03, 2011

Shape and Cutting Style **Cushion Modified Brilliant**

Measurements 4.57 x 4.54 x 3.05 mm

GRADING RESULTS

Carat Weight **0.54 carat**

Color

Origin **NATURAL**

Grade **FANCY**

..... **YELLOW**

Distribution **Even**

Clarity Grade **VS2**

ADDITIONAL GRADING INFORMATION

Finish

Polish Very Good

Symmetry Good

Fluorescence None

Comments:

Additional clouds are not shown.

REFERENCE DIAGRAMS

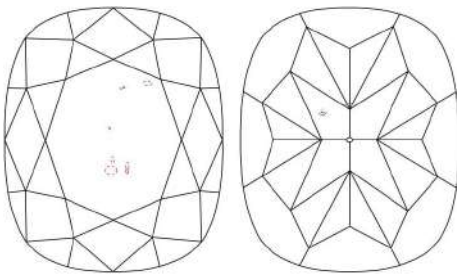

GIA CLARITY SCALE	
FLAWLESS	
INTERNALLY FLAWLESS	
VERY VERY SLIGHTLY INCLUDED	VVS ₁
	VVS ₂
VERY SLIGHTLY INCLUDED	VS ₁
	VS ₂
SLIGHTLY INCLUDED	S ₁
	S ₂
INCLUDED	I ₁
	I ₂
	I ₃

GIA COLORED DIAMOND SCALE

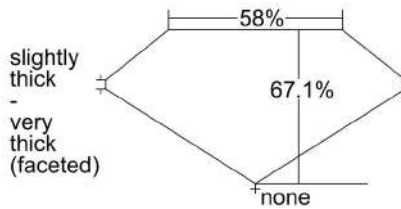
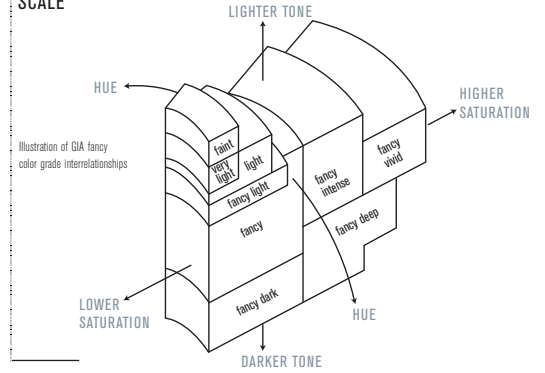

Profile not to actual proportions

KEY TO SYMBOLS

- Crystal
- Knot
- Cloud
- ~ Feather

Red symbols denote internal characteristics (inclusions). Green or black symbols denote external characteristics (blemishes). Diagram is an approximate representation of the diamond, and symbols shown indicate type, position, and approximate size of clarity characteristics. All clarity characteristics may not be shown. Details of finish are not shown.

This is a digital representation of the original GIA Report. To verify the information herein, please refer to reportcheck.gia.edu. This Report is not a guarantee, valuation or appraisal and contains only the characteristics of the diamond described herein after it has been graded, tested, examined and analyzed by the laboratory providing this Report ("GIA") and/or has been inscribed using the techniques and equipment used by GIA at the time of the examination and/or inscription. Inscriptions reported in this document are not a guarantee, validation, or warranty of a diamond's quality, country of origin or source; or that the diamond will be identifiable by the inscription in the future (since inscriptions can be removed). GIA makes no representation concerning any trademark, word, or symbol which is inscribed by GIA or which is identified on this Report. The recipient of this Report may wish to consult a credentialed jeweler or gemologist about the information contained herein.

For terms, conditions, and limitations, see www.gia.edu/terms or call 800-421-7250 or 760-603-4500.



GIA COLORED DIAMOND REPORT

January 13, 2014

Report Type Grading Report

GIA Report Number 3165588229

Shape and Cutting Style Round Brilliant

Measurements 4.69 - 4.71 x 2.92 mm

Carat Weight 0.40 carat

Color Grade Very Light Green

Color Origin Natural

Color Distribution Not Applicable

Clarity Grade VS2

Proportions:

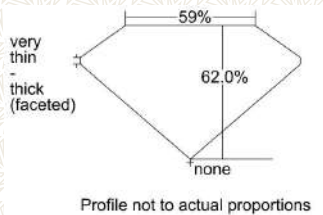

Polish Excellent

Symmetry Excellent

Fluorescence None

Comments: A patch of color is not shown.

ADDITIONAL INFORMATION

GIA COLORED DIAMOND SCALE

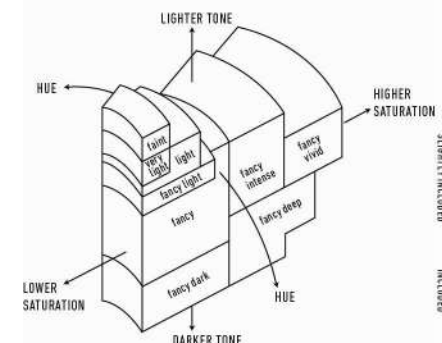
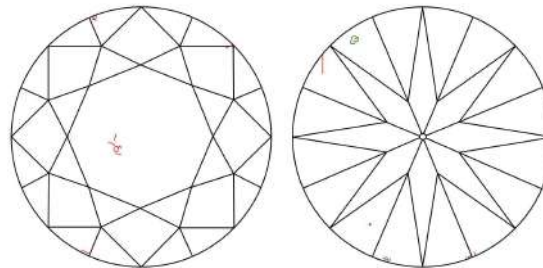

Illustration of GIA fancy color grade interrelationships

GIA CLARITY SCALE

FLAWLESS
INTERNALLY FLAWLESS
VVS ₁
VVS ₂
VS ₁
VS ₂
SI ₁
SI ₂
I ₁
I ₂
I ₃

CLARITY CHARACTERISTICS



KEY TO SYMBOLS*

- Crystal
- Pinpoint
- Cloud
- Indented Natural
- Cavity
- Feather

* Red symbols denote internal characteristics (inclusions). Green or black symbols denote external characteristics (blemishes). Diagram is an approximate representation of the diamond, and symbols shown indicate type, position, and approximate size of clarity characteristics. All clarity characteristics may not be shown. Details of finish are not shown.



The results documented in this report refer only to the diamond described, and were obtained using the techniques and equipment used by GIA at the time of examination. This report is not a guarantee or valuation. For additional information and important limitations and disclaimers, please see www.gia.edu/terms or call +1 800 421 7250 or +1 760 603 4500. ©2014 Gemological Institute of America, Inc.

reportcheck.gia.edu



 THE SECURITY FEATURES IN THIS DOCUMENT, INCLUDING THE HOLOGRAM, SECURITY SCREEN AND MICROPRINT LINES, IN ADDITION TO THOSE NOT LISTED, EXCEED DOCUMENT SECURITY INDUSTRY GUIDELINES.



COLORED DIAMOND GRADING REPORT

GIA REPORT 2141837363

August 02, 2012
Shape and Cutting Style **Cushion Modified Brilliant**
Measurements 5.13 x 4.33 x 2.81 mm

GRADING RESULTS

Carat Weight **0.53 carat**
Color **NATURAL**
Origin **FANCY**
Grade **YELLOW**
Distribution **Even**
Clarity Grade **S11**

ADDITIONAL GRADING INFORMATION

Finish
Polish Very Good
Symmetry Good
Fluorescence None
Comments:
Additional extra facets are not shown.

REFERENCE DIAGRAMS

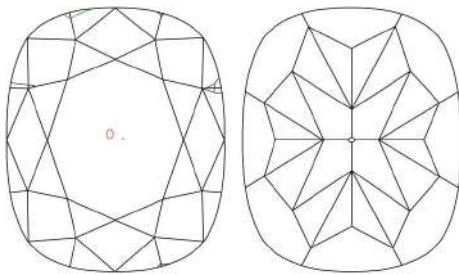

GIA CLARITY SCALE	
FLAWLESS	INCLUDED
INTERNALLY FLAWLESS	
VVS ₁	VERY VERY SLIGHTLY INCLUDED
VVS ₂	
VS ₁	VERY SLIGHTLY INCLUDED
VS ₂	
S1 ₁	SLIGHTLY INCLUDED
S1 ₂	
I ₁	INCLUDED
I ₂	
I ₃	

GIA COLORED DIAMOND SCALE

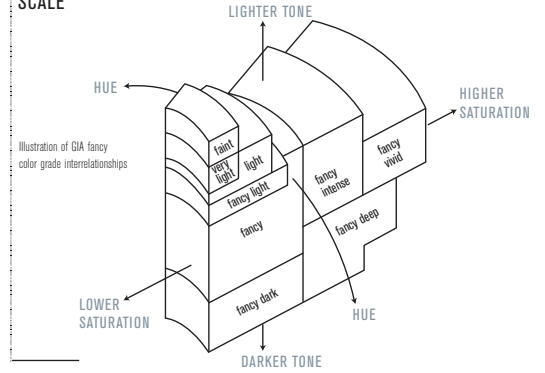

210117460696

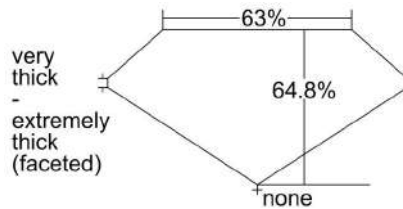

KEY TO SYMBOLS

- Crystal
- Pinpoint
- ▲ Natural
- ▲ Extra Facet

Red symbols denote internal characteristics (inclusions). Green or black symbols denote external characteristics (blemishes). Diagram is an approximate representation of the diamond, and symbols shown indicate type, position, and approximate size of clarity characteristics. All clarity characteristics may not be shown. Details of finish are not shown.

This is a digital representation of the original GIA Report. To verify the information herein, please refer to reportcheck.gia.edu. This Report is not a guarantee, valuation or appraisal and contains only the characteristics of the diamond described herein after it has been graded, tested, examined and analyzed by the laboratory providing this Report ("GIA") and/or has been inscribed using the techniques and equipment used by GIA at the time of the examination and/or inscription. Inscriptions reported in this document are not a guarantee, validation, or warranty of a diamond's quality, country of origin or source; or that the diamond will be identifiable by the inscription in the future (since inscriptions can be removed). GIA makes no representation concerning any trademark, word, or symbol which is inscribed by GIA or which is identified on this Report. The recipient of this Report may wish to consult a credentialed jeweler or gemologist about the information contained herein.

For terms, conditions, and limitations, see www.gia.edu/terms or call 800-421-7250 or 760-603-4500.



